



# PRODUCT PRICE LIST 2023 USA



PRICES IN EFFECT APRIL 1, 2023  
RELEASE: 23-2A (July 2023)

### QUICK REFERENCE:

Air Curtains .....	<a href="#">Pages 6 to 8</a>
High Intensity Infrared Heaters .....	<a href="#">Pages 9 to 11</a>
Low Intensity Radiant Tube Heaters .....	<a href="#">Pages 12 to 45</a>
Outdoor Infrared Heaters .....	<a href="#">Pages 46 to 58</a>
MonsterFans .....	<a href="#">Pages 59 to 60</a>

### Infrasave

2 Schwank Way  
Waynesboro, GA 30830

Orders, Customer Service & Technical Support

**1-877-686-3779**

**Fax: 1-866-361-0523**

Design Services

**1-877-686-3779**

**Fax: 1-866-361-0523**

Inquiry email: [csr@infrasave.com](mailto:csr@infrasave.com)

Visit our website for current product information

[www.infrasave.com](http://www.infrasave.com)

Select PUBLISHED INFO from menu, then Register or Login



**These price sheets are the proprietary information of Infrasave. This publication, or parts thereof, may not be reproduced in any form or reposted electronically without prior written consent from Infrasave. Unauthorized use or distribution is strictly prohibited.**

Infrasave gas-fired heaters are certified by UL



**As of the effective date, these price sheets supersede all previous price sheets.**

## PRICE LIST RELEASE NOTES

### July 2023 Release Notes:

- a. Swift5 Air Curtains: Price reduced by 10%
- b. ITT Two Stage Heaters - Price reduced by 10%
- c. MonsterFans products - Added to the pricelist, See page 59

Download Product Information and Price List Updates at:

**[www.infrasave.com](http://www.infrasave.com) - Get current Published Info for all products**

## TABLE OF CONTENTS

	Price List Release Notes & Product Notes .....	Previous Page
	<b>General Info: Credit Terms, Returns Policy, Charge Backs .....</b>	5
<b>AIR CURTAINS</b>	<b>Infrasave Air Curtains.....</b>	6 to 8
<b>HIGH INTENSITY HEATERS</b>	<b>IL Series High Intensity Heaters.....</b>	9
	Accessories for IL High Efficiency Heaters.....	10
	Gas Conversion Kits for IL High Efficiency Heaters.....	10
	Gas Conversion Kits for IO-100 & IO-210 Outdoor High Efficiency Heaters.....	10
	<b>24V Transformers for IL Series High Intensity Heaters .....</b>	11
<b>TUBE HEATERS</b>	<b>General Information: All Tube Heater Models.....</b>	12
	24V Control Guidelines for Tube Heaters.....	13
Residential	<b>P40-R Workshop/Garage Factory Assembled Tube Heater &amp; Accessories.....</b>	14
Commercial / Industrial Indoor Applications		
Packaged Series	<b>P40U-I Series Factory Assembled &amp; Packaged Tube Heater Systems .....</b>	15
Premier Series	<b>IQ Series Positive Pressure Tube Heater Systems .....</b>	16
	IQ Series Burner Kits & Tube Kits.....	17
	<b>ITB Series Tube Heater Complete Systems.....</b>	18
	ITB Burner Kits & Tube Kits.....	19
Value Performance Series	<b>ITBU Series Tube Heaters Complete Systems .....</b>	20
	ITBU Burner Kits & Tube Kits.....	21
Two Stage	<b>ITT Series Tube Heater Complete Systems &amp; Kit Assembly Chart .....</b>	22
	ITT Burner Kits & Tube Kits.....	23
	<b>ITTU Tube Heater Complete Systems .....</b>	24
	ITTU Burner Kits & Tube Kits.....	25
	<b>Optional Accessories for Indoor Tube Heaters [IQ, ITB/U, ITT/U].....</b>	26
	<b>Thermostats &amp; Controls for Indoor Application Tube Heaters .....</b>	28
<b>ENERGY MANAGEMENT</b>	<b>TruTemp Infrared Setback Thermostat .....</b>	29
	<b>Arena Heating Guidelines &amp; Control Panels .....</b>	30
<b>OUTDOOR &amp; CAR WASH</b>	<b>Harsh Environment &amp; Outdoor Tube Heaters: Introduction .....</b>	31
IWP has Powder Coated Housing	<b>IWP Series Outdoor Patio &amp; Carwash Tube Heater Complete Systems .....</b>	32
	IWP Burner Kits & Tube Kits.....	33
	<b>IWP2 2-Stage Series Outdoor Patio &amp; Carwash Tube Heater Complete Systems .....</b>	34
	IWP2 Burner Kits & Tube Kits.....	35
IW has Stainless Steel Housing	<b>IW Series Outdoor Patio &amp; Carwash Tube Heater Complete Systems .....</b>	36
	IW Burner Kits & Tube Kits .....	37
	<b>IW2 2-Stage Series Outdoor Patio &amp; Carwash Tube Heater Complete Systems .....</b>	38
	IW2 Burner Kits & Tube Kits .....	39

continued next page .....

## TABLE OF CONTENTS [continued]

IWS Series with Stainless Steel Housing, Tubes & Reflectors	<b>IWS Series Harsh Environment Heaters</b> .....	40
	IWS Series Stainless Steel Burner Kts & Tube Kits .....	41
	<b>IW2S 2-Stage Series Harsh Environment Heaters</b> .....	42
	IW2S Series Stainless Steel Burner Kts & Tube Kits .....	43
<hr/>		
	<b>Optional Accessories for Outdoor IW &amp; IWP Tube Heaters</b> .....	44
<hr/>		
<b>OUTDOOR HEAT</b>	<b>Patio Heater Selection Guidelines</b> .....	46
Single & 2-Stage	<b>Outdoor IO-100 Series High Intensity Heaters &amp; Accessories</b> .....	47
	<b>Outdoor IO-210 Series High Intensity Heaters &amp; Accessories</b> .....	48
<hr/>		
	<b>Mounting Hardware Options for IO-100 &amp; IO-210 Series Heaters</b> .....	49
	<b>Remote Control &amp; Patio Panel ~ Central control of Patio systems</b> .....	50
	<b>Patio - 24V Option Guidelines</b> .....	50
	<b>2-Stage Controls &amp; 24V Transformers for IO-100 &amp; IO-210 Series Heaters</b> .....	51
<hr/>		
Great under Canopy or Roof	<b>Outdoor Tube Heater Summary (Heaters on pages 31 to 43)</b> .....	52
<hr/>		
Portable	<b>Patio 4000-CB Series Parasol Heaters</b> .....	53
<hr/>		
<b>ELECTRIC IR</b>	<b>EL/ELD Series Mid-Wave Infrared Heaters - Instant Comfort Indoor/Outdoor</b> .....	54
	<b>Electric Heater Controls</b> .....	55
<hr/>		
<b>MISCELLANEOUS</b>	Gas Conversion Kits for all Infrasave Heater Series .....	58
	Product Warranty Summary .....	59

Tube heaters are shipped as 'Burner Kits' & 'Tube Kits' in separate cartons

### These price sheets supersede all other price sheets

Infrasave reserves the right to make changes in products and pricing without notice.

F.O.B. Mississauga, Ontario

All Applicable Taxes Extra

Terms: Net 30 Days

1 1/2% Monthly Interest On Overdue Accounts

Prices subject to change without notice

## Credit Terms

When credit is extended by Infrasave the terms are: Net 30 days

1% Monthly Interest On Overdue Accounts

**Minimum Invoice:** A minimum order of \$50.00 is required for invoicing

## Infrasave Returns Policy

**Please contact Customer Service regarding any product return: 1-877-686-3779; [csr@infrasave.com](mailto:csr@infrasave.com)**

Approval must be issued in advance by Infrasave before any returns will be accepted.

All goods being returned must be accompanied by a completed Return Authorization form.

Infrasave reserves the right to disallow the return of sold goods.

### Warranty Parts

Infrasave is proud of the quality of the products we manufacture; Some component parts can fail occasionally.

If a component failure occurs, the following procedure must be followed:

- 1 The heater MODEL # & SERIAL # are required before contacting customer service
- 2 Contact Infrasave to determine if the item needs to be returned or if the item will be field scrapped
- 3 For the return of a component part a Return Authorization form will be provided by Infrasave
  - a. Item must be returned shipping "Prepaid" unless otherwise agreed beforehand
  - b. Any unauthorized "Collect" shipments will be refused

### Restocking Returns

To return an item for credit against an invoice within 30 days of purchase:

- 1 Contact Infrasave customer service to be issued a Return Authorization Form [RGA]
- 2 The RGA must accompany any return
- 3 Any item must be returned shipping "Prepaid" unless otherwise agreed by Infrasave
- 4 Returned items must be in "new condition" and in original packaging / carton
- 5 Upon receipt of the product and RGA, the credit amount will be determined:
  - a. Items returned are subject to a 25% restocking charge
  - b. Items that are missing or in need of repair or repackaging will have associated costs deducted from credit

## Charge Backs

A heater must be properly commissioned and the Commissioning Form accurately completed and returned to Infrasave. A Commissioning Form is located in the I&O Manual supplied with each heater.

Any charge back claim must be approved in writing by Infrasave Technical Services prior to commencement of work.

## Freight Zones & Charges

Refer to Infrasave Website



Swift5 Series



Breeze9 Series

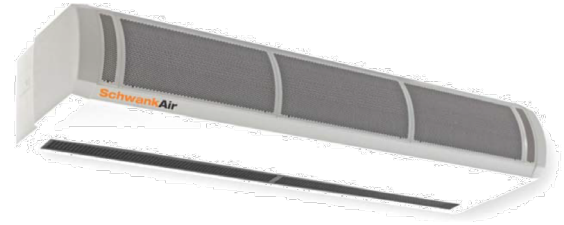

Breeze8 Series

## Surface Mount Air Curtains

STACK MODELS OF SAME SERIES END-TO-END FOR WIDER DOORS  
REFER TO BROCHURE, MANUAL, OR SUBMITTAL DATA FOR DETAILED SPECIFICATIONS

### Swift5

Model	Max. Door Height	CFM	Curtain Heat Output			Dimensions (Inches)			Part Number	LIST PRICE
			(Btuh)	kW	FLA	Length	Height	Depth		
<b>1500 Series: SURFACE MOUNT - ELECTRIC HEAT - 208/1/60</b>										
1532EH	7' 6"	200	3,860 / 7,685	2.5/3.7	19	32	8	5	AC-ME32-20-WH	\$ 1,204.00
1532EH	7' 6"	200	8,400 / 16,770	2.5/3.7	19	32	8	5	AC-ME32-20-BK	1,204.00

### Breeze9

Model	Max. Door Height	CFM	Curtain Heat Output			Dimensions (Inches)			Part Number	LIST PRICE
			(Btuh)	kW	FLA	Length	Height	Depth		
<b>1200 Series: SURFACE MOUNT - AMBIENT [NO HEAT] - 120/1/60 : w/ WIRELESS REMOTE &amp; DOOR SWITCH - BLACK COLOR ONLY</b>										
1036	9'	1177 / 942	-	-	3.2	37.2	10.2	8.7	AC-1036-12-BK	\$ 1,212.00
1048	9'	1648 / 1295	-	-	4.5	49.2	10.2	8.7	AC-1048-12-BK	\$ 1,542.00
1060	9'	2119 / 1648	-	-	5.75	61.2	10.2	8.7	AC-1060-12-BK	\$ 1,763.00

### Breeze8

Model	Max. Door Height	CFM	Curtain Heat Output			Dimensions (Inches)			Part Number	LIST PRICE
			(Btuh)	kW	FLA	Length	Height	Depth		
<b>2000 Series: SURFACE MOUNT - AMBIENT [NO HEAT] - 230/1/60 : w/ WIRED CONTROL &amp; DOOR SWITCH</b>										
2045	10'	740	-	-	0.5	45	8	11	AC-CA45-23	\$ 3,299.00
2066	10'	1060	-	-	0.7	66	8	11	AC-CA66-23	3,775.00
2087	10'	1470	-	-	1	87	8	11	AC-CA87-23	4,799.00
<b>2000 Series: SURFACE MOUNT - ELECTRIC HEAT - 208/3/60 : w/ WIRED CONTROL &amp; DOOR SWITCH</b>										
2045EH	10'	740	15,370 / 30,735	4.5 / 9	24.5	45	8	11	AC-CE45-20	\$ 3,486.00
2066EH	10'	1060	20,490 / 40,980	6 / 12	32.7	66	8	11	AC-CE66-20	3,871.00
2087EH	10'	1470	30,735 / 61,470	9 / 18	49	87	8	11	AC-CE87-20	6,223.00
<b>2000 Series: SURFACE MOUNT - ELECTRIC HEAT - 480/3/60 : w/ WIRED CONTROL &amp; DOOR SWITCH</b>										
2045EH	10'	740	15,370 / 30,735	4.5 / 9	10.9	45	8	11	AC-CE45-48	\$ 3,486.00
2066EH	10'	1060	20,490 / 40,980	6 / 12	13.5	66	8	11	AC-CE66-48	3,871.00
2087EH	10'	1470	30,735 / 61,470	9 / 18	21.7	87	8	11	AC-CE87-48	6,223.00
<b>2000 Series: SURFACE MOUNT - ELECTRIC HEAT - 600/3/60 : w/ WIRED CONTROL &amp; DOOR SWITCH</b>										
2045EH	10'	740	15,370 / 30,735	4.5 / 9	9.3	45	8	11	AC-CE45-60	\$ 3,486.00
2066EH	10'	1060	20,490 / 40,980	6 / 12	12.8	66	8	11	AC-CE66-60	3,871.00
2087EH	10'	1470	30,735 / 61,470	9 / 18	18.6	87	8	11	AC-CE87-60	6,223.00
<b>2000 Series: SURFACE MOUNT - HOT WATER HEAT - 230/1/60 : w/ WIRED CONTROL &amp; DOOR SWITCH</b>										
2045WH	10'	700	10,245 / 20,490	3 / 6	0.5	45	8	11	AC-CW45-23	\$ 3,693.00
2066WH	10'	1000	15,370 / 30,735	4.5 / 9	0.7	66	8	11	AC-CW66-23	4,316.00
2087WH	10'	1400	20,490 / 40,980	6 / 12	1	87	8	11	AC-CW87-23	5,651.00



Breeze10 Series

## Surface Mount Air Curtains - Breeze10 Series

STACK MODELS OF SAME SERIES END-TO-END FOR WIDER DOORS  
REFER TO BROCHURE, MANUAL, OR SUBMITTAL DATA FOR DETAILED SPECIFICATIONS

### Breeze10

Model	Max. Door	CFM	Curtain Heat Output			Dimensions (Inches)			Part Number	LIST PRICE
	Height		(Btuh)	kW	FLA	Length	Height	Depth		
<b>2500 Series: SURFACE MOUNT - AMBIENT [NO HEAT] - 230/1/60 : w/ WIRED CONTROL &amp; DOOR SWITCH</b>										
2551	11' 6"	900	-	-	1.4	51.2	12.1	18.4	AC-HA51-23	\$ 4,697.00
2572	11' 6"	1315	-	-	2	71.9	12.1	18.4	AC-HA72-23	6,336.00
2593	11' 6"	1735	-	-	2.8	92.5	12.1	18.4	AC-HA93-23	7,811.00
<b>2500 Series: SURFACE MOUNT - ELECTRIC HEAT - 208/3/60 : w/ WIRED CONTROL &amp; DOOR SWITCH</b>										
2551EH	11' 6"	810	20,473 / 40,946	6 / 12	36	51.2	12.1	18.4	AC-HE51-20	\$ 6,128.00
2572EH	11' 6"	1165	40,946 / 61,418	12 / 18	54	71.9	12.1	18.4	AC-HE72-20	8,294.00
2593EH	11' 6"	1460	40,946 / 81,891	12 / 24	72	92.5	12.1	18.4	AC-HE93-20	10,151.00
<b>2500 Series: SURFACE MOUNT - ELECTRIC HEAT - 480/3/60 : w/ WIRED CONTROL &amp; DOOR SWITCH</b>										
2551EH	11' 6"	900	20,473 / 40,946	6 / 12	13.5	51.2	12.1	18.4	AC-HE51-48	\$ 6,128.00
2572EH	11' 6"	1315	40,946 / 61,418	12 / 18	21.7	71.9	12.1	18.4	AC-HE72-48	8,294.00
2593EH	11' 6"	1735	40,946 / 81,891	12 / 24	28.9	92.5	12.1	18.4	AC-HE93-48	10,151.00
<b>2500 Series: SURFACE MOUNT - ELECTRIC HEAT - 600/3/60 : w/ WIRED CONTROL &amp; DOOR SWITCH</b>										
2551EH	11' 6"	900	20,473 / 40,946	6 / 12	11.6	51.2	12.1	18.4	AC-HE51-60	\$ 6,128.00
2572EH	11' 6"	1315	40,946 / 61,418	12 / 18	17.3	71.9	12.1	18.4	AC-HE72-60	8,294.00
2593EH	11' 6"	1735	40,946 / 81,891	12 / 24	23.1	92.5	12.1	18.4	AC-HE93-60	10,151.00
<b>2500 Series: SURFACE MOUNT - HOT WATER HEAT - 230/1/60 : w/ WIRED CONTROL &amp; DOOR SWITCH</b>										
2551WH	11' 6"	900	20,473 / 40,946	6 / 12	1.4	51.2	12.1	18.4	AC-HW51-23	\$ 6,128.00
2572WH	11' 6"	1315	30,709 / 61,418	9 / 18	2	71.9	12.1	18.4	AC-HW72-23	8,294.00
2593WH	11' 6"	1735	40,946 / 81,891	12 / 24	2.8	92.5	12.1	18.4	AC-HW93-23	10,151.00



## Recessed Mount Air Curtains

### Breeze8R & Breeze10R Series

(Mount in ceiling recess above door and discharge downward)

STACK MODELS OF SAME SERIES END-TO-END FOR WIDER DOORS

<b>Breeze8R</b>		<u>Max. Door</u>	<u>Curtain Heat Output</u>			<u>Dimensions (Inches)</u>			<u>Part Number</u>	<u>LIST PRICE</u>
<u>Model</u>	<u>Height</u>	<u>CFM</u>	<u>(Btuh)</u>	<u>kW</u>	<u>FLA</u>	<u>Length</u>	<u>Height</u>	<u>Depth</u>		
<b>2000R Series: SURFACE MOUNT - AMBIENT [NO HEAT] - 230/1/60 : w/ WIRED CONTROL &amp; DOOR SWITCH</b>										
2047R	9'	740	-	-	0.5	47	8	14	AC-CA47-23-R	\$ 3,737.00
2063R	9'	1060	-	-	0.7	63	8	14	AC-CA63-23-R	4,634.00
2083R	9'	1470	-	-	1	83	8	14	AC-CA83-23-R	5,779.00
<b>2000R Series: SURFACE MOUNT - ELECTRIC HEAT - 208/3/60 : w/ WIRED CONTROL &amp; DOOR SWITCH</b>										
2047EHR	9'	740	15,370 / 30,735	4.5 / 9	24.5	47	8	14	AC-CE47-20-R	\$ 4,653.00
2063EHR	9'	1060	20,490 / 40,980	6 / 12	32.7	63	8	14	AC-CE63-20-R	5,454.00
2083EHR	9'	1470	30,735 / 61,470	9 / 18	49	83	8	14	AC-CE83-20-R	8,085.00
<b>2000R Series: SURFACE MOUNT - ELECTRIC HEAT - 480/3/60 : w/ WIRED CONTROL &amp; DOOR SWITCH</b>										
2047EHR	9'	740	15,370 / 30,735	4.5 / 9	10.9	47	8	14	AC-CE47-48-R	\$ 4,653.00
2063EHR	9'	1060	20,490 / 40,980	6 / 12	13.5	63	8	14	AC-CE63-48-R	5,454.00
2083EHR	9'	1470	30,735 / 61,470	9 / 18	21.7	83	8	14	AC-CE83-48-R	8,085.00
<b>2000R Series: SURFACE MOUNT - ELECTRIC HEAT - 600/3/60 : w/ WIRED CONTROL &amp; DOOR SWITCH</b>										
2047EHR	9'	740	15,370 / 30,735	4.5 / 9	9.3	47	8	14	AC-CE47-60-R	\$ 4,653.00
2063EHR	9'	1060	20,490 / 40,980	6 / 12	12.8	63	8	14	AC-CE63-60-R	5,454.00
2083EHR	9'	1470	30,735 / 61,470	9 / 18	18.6	83	8	14	AC-CE83-60-R	8,085.00
<b>2000R Series: SURFACE MOUNT - HOT WATER HEAT - 230/1/60 : w/ WIRED CONTROL &amp; DOOR SWITCH</b>										
2047WHR	9'	700	10,245 / 20,490	3 / 6	0.5	47	8	14	AC-CW47-23-R	\$ 4,792.00
2063WHR	9'	1000	15,370 / 30,735	4.5 / 9	0.7	63	8	14	AC-CW63-23-R	5,714.00
2083WHR	9'	1400	20,490 / 40,980	6 / 12	1	83	8	14	AC-CW83-23-R	7,976.00
<b>Breeze10R</b>		<u>Max. Door</u>	<u>Curtain Heat Output</u>			<u>Dimensions (Inches)</u>			<u>Part Number</u>	<u>LIST PRICE</u>
<u>Model</u>	<u>Height</u>	<u>CFM</u>	<u>(Btuh)</u>	<u>kW</u>	<u>FLA</u>	<u>Length</u>	<u>Height</u>	<u>Depth</u>		
<b>2500R Series: SURFACE MOUNT - AMBIENT [NO HEAT] - 230/1/60 : w/ WIRED CONTROL &amp; DOOR SWITCH</b>										
2547R	11' 6"	900	-	-	1.4	46.7	13.7	19.1	AC-HA47-23-R	\$ 5,561.00
2567R	11' 6"	1315	-	-	2	67.3	13.7	19.1	AC-HA67-23-R	7,526.00
2588R	11' 6"	1735	-	-	2.8	88	13.7	19.1	AC-HA88-23-R	9,222.00
<b>2500R Series: SURFACE MOUNT - ELECTRIC HEAT - 208/3/60 : w/ WIRED CONTROL &amp; DOOR SWITCH</b>										
2547EHR	11' 6"	810	20,473 / 40,946	6 / 12	36	46.7	13.7	19.1	AC-HE47-20-R	\$ 7,271.00
2567EHR	11' 6"	1165	40,946 / 61,418	12 / 18	54	67.3	13.7	19.1	AC-HE67-20-R	9,819.00
2588EHR	11' 6"	1460	40,946 / 81,891	12 / 24	72	88	13.7	19.1	AC-HE88-20-R	12,038.00
<b>2500R Series: SURFACE MOUNT - ELECTRIC HEAT - 480/3/60 : w/ WIRED CONTROL &amp; DOOR SWITCH</b>										
2547EHR	11' 6"	900	20,473 / 40,946	6 / 12	13.5	46.7	13.7	19.1	AC-HE47-48-R	\$ 7,271.00
2567EHR	11' 6"	1315	40,946 / 61,418	12 / 18	21.7	67.3	13.7	19.1	AC-HE67-48-R	9,819.00
2588EHR	11' 6"	1735	40,946 / 81,891	12 / 24	28.9	88	13.7	19.1	AC-HE88-48-R	12,038.00
<b>2500R Series: SURFACE MOUNT - ELECTRIC HEAT - 600/3/60 : w/ WIRED CONTROL &amp; DOOR SWITCH</b>										
2547EHR	11' 6"	900	20,473 / 40,946	6 / 12	11.6	46.7	13.7	19.1	AC-HE47-60-R	\$ 7,271.00
2567EHR	11' 6"	1315	40,946 / 61,418	12 / 18	17.3	67.3	13.7	19.1	AC-HE67-60-R	9,819.00
2588EHR	11' 6"	1735	40,946 / 81,891	12 / 24	23.1	88	13.7	19.1	AC-HE88-60-R	12,038.00
<b>2500R Series: SURFACE MOUNT - HOT WATER HEAT - 230/1/60 : w/ WIRED CONTROL &amp; DOOR SWITCH</b>										
2547WHR	11' 6"	900	20,473 / 40,946	6 / 12	1.4	46.7	13.7	19.1	AC-HW47-23-R	\$ 7,271.00
2567WHR	11' 6"	1315	30,709 / 61,418	9 / 18	2	67.3	13.7	19.1	AC-HW67-23-R	9,819.00
2588WHR	11' 6"	1735	40,946 / 81,891	12 / 24	2.8	88	13.7	19.1	AC-HW88-23-R	12,044.00





Typical accessories are listed below.  
 Other Accessories: next page  
 Transformers: page 11

## IL SERIES HIGH INTENSITY HEATERS

Notes: IL 25 : NG Only; LP Discontinued

IL Series heaters include assembled reflectors, gas valve and electronic ignition control. Optional accessories are listed below, and on next page.

MODEL		CAPACITY	GAS	PART #	LIST PRICE
IL 25	NG ONLY	21,500 Btuh	NG ONLY	IL-0025-NG	\$ 794.00
IL 37	N or L	35,000 Btuh	NG	IL-0037-NG	829.00
			LP	IL-0037-LP	829.00
IL 50	N or L	50,000 Btuh	NG	IL-0050-NG	998.00
			LP	IL-0050-LP	998.00
IL 75	N or L	65,000 Btuh	NG	IL-0075-NG	1,156.00
			LP	IL-0075-LP	1,156.00
IL 100	N or L	100,000 Btuh	NG	IL-0100-NG	1,280.00
			LP	IL-0100-LP	1,280.00
IL 150	N or L	143,000 Btuh	NG	IL-0150-NG	2,138.00
			LP	IL-0150-LP	2,138.00
IL 200	N or L	200,000 Btuh	NG	IL-0200-NG	2,344.00
			LP	IL-0200-LP	2,344.00

IL Series Heaters require 24 volt connection

### TYPICAL OPTIONAL ACCESSORIES FOR IL SERIES

- Flexible Gas Connector 1/2" X 24" [up to 150,000 Btuh]
- Flexible Gas Connector 3/4" x 36" - for ECO 52
- #8 Jack Chain - 60 lb work load - box 50'
- #2 Lion Chain - 115 lb work load - 200 ft roll
- 'S' Hooks - Package of 25



Safety Snap Hooks - 2"

Package of 24  
 Package of 100

Pressure Equalizer Venturi Cover [for drafty areas]  
 Note: IL 150 & 200 require two Venturi Covers

PART #	LIST PRICE
JL-0771-XX	\$ 59.00
JL-0771-YY	186.00
JL-0798-JC	109.00
JL-0800-XX	175.00
JL-0798-SH	41.00
JL-0800-SH	72.00
JL-0800-SH-B	220.00
JO-0368-XX	284.00

### THERMOSTATS - For 24V Thermostat control requirements see 'Guidelines' page 11

- Line Voltage [120V] Thermostat
- Low Voltage [24V] Digital Thermostat °F & °C  
 [Requires Control Center JM-0300-AA below for multiple heaters]
- TruTemp Set Back Infra-red Thermostat [24V]  
 [Requires Control Center JM-0300-AA below for multiple heaters]
- Transformer/Relay [Required for 24V Control of Multiple Heaters]

JL-0772-XX	\$ 70.00
JS-0569-WR	118.00
JM-0150-XX	251.00
JM-0300-AA	194.00

## MORE ACCESSORIES for IL SERIES HIGH INTENSITY HEATERS

Typical Accessories: previous page

Transformers: next page

### TILE PROTECTING GRILLE: longer lead times for this accessory

[1/2" X 1/2" Bird Screen]

For: IL 25  
IL 37  
IL 50  
IL 75  
IL 100

PART #	LIST PRICE
JX-0249-XX	\$ 49.00
JX-0252-XX	89.00
JX-0253-XX	89.00
JX-0254-XX	94.00
JX-0255-XX	96.00

### REFLECTOR EXTENSIONS - Single Side - Order Quantity 2 if both sides require extension

For: IL 25 Single Side  
IL 37 Single Side  
IL 50 Single Side  
IL 75 Single Side  
IL 100 Single Side

JX-0260-SG-P	\$ 76.00
JX-0236-SG-P	115.00
JX-0237-SG-P	120.00
JX-0238-SG-P	154.00
JX-0239-SG-P	229.00

### Field Conversion for Fuel Gas: 'IL' Series High Intensity Heaters

IL 37  
IL 50  
IL 75  
IL 100  
IL 150  
IL 200

#### NG to LP

JX-0253-XA  
JX-0253-XB  
JX-0253-XC  
JX-0253-XD  
JX-0253-XC-A  
JX-0253-XD-A

#### LP to NG

JX-0252-XA  
JX-0252-XB  
JX-0252-XC  
JX-0252-XD  
JX-0252-XC-A  
JX-0252-XD-A

\$ 87.00  
87.00  
87.00  
87.00  
104.00  
104.00

### Gas Conversion Kits: Outdoor High Intensity IO-100 & IO-210 Series

		PART #	LIST PRICE
IO-100 Series NG to LP	CONV. KIT - NG TO LP - IO-135	JX-0253-XH	\$ 109.00
	CONV. KIT - NG TO LP - IO-150	JX-0253-XJ	110.00
IO-210 Series NG to LP	CONV. KIT - NG TO LP - IO-212	JX-0253-XE	87.00
	CONV. KIT - NG TO LP - IO-213	JX-0253-XF	87.00
IO-100 Series LP to NG	CONV. KIT - LP TO NG - IO-135	JX-0252-XH	109.00
	CONV. KIT - LP TO NG - IO-150	JX-0252-XJ	108.00
IO-210 Series LP to NG	CONV. KIT - LP TO NG - IO-212	JX-0252-XE	87.00
	CONV. KIT - LP TO NG - IO-213	JX-0252-XF	87.00

Models IO-152 & IO-252 are NG Only, and Not Convertible to LP

## 24V TRANSFORMERS for IL HIGH INTENSITY HEATERS

<u>QTY HEATERS*</u>	<u>REQUIRED SIZE</u>		<u>PART #</u>	<u>LIST PRICE</u>
1 heater	40 VA Transformer	4"x4" Electrical Box Mount	JL-0776-XX	\$ 126.00
Up to 4	100 VA Transformer	Closed Type	JL-0778-XX	234.00
5 to 6	150 VA Transformer	Closed Type	JL-0779-XX	281.00
7 to 9	200 VA Transformer	Closed Type	JL-0780-XX	321.00
10 to 12	250 VA Transformer	Closed Type	JL-0781-XX	350.00
13 to 16	350 VA Transformer	Closed Type	JL-0781-AA	409.00

\* Except patio heaters - see below for sizing guidelines

See **INSTALLATION MANUAL** to determine gauge of wire to be used. [minimum 16 gauge].

### 24V TRANSFORMER SIZING:

#### **For Space Heating & Process Applications**

- 1] Transformer mounted at heater:  
Use 40 VA 24V Transformer for each single heater.
- 2] Transformer mounted remote from heater:
  - On a single heater use one 40 VA 24V transformer.
  - On a zone with multiple heaters, use transformer sized at 40VA per first heater plus 20VA for each additional heater

#### **For Outdoor IO-100 & IO-210 Series**

- On a single heater use one 40 VA 24V transformer.
- On a zone or Patio Panel with multiple heaters, use transformer sized at 40 VA per first heater and 20 VA per each additional heater.

**Zone Sizing Guidelines:** The number of heaters in a zone is determined by any of the following parameters:

- 1) The capacity of the exhaust fan that can capably service the zone
- 2) Proximity of heaters to fan: horizontal distance between any heater and fan = maximum 6 times mounting height
- 3) Quantity of heaters required to satisfy conditions at the project site

## HIGH INTENSITY HEATER 24V CONTROL OPTION GUIDELINES

for: TruTemp / 24V Thermostat ... Page 33

<b>Single heater per low voltage control zone requires one 40VA transformer [JL-0776-XX] per heater</b>
<b>Multiple heaters per zone:</b> Maximum 15 heaters per TruTemp or 24V Thermostat
<b>ORDER per ZONE - 1 TruTemp or 24V Thermostat + 1 Transformer Relay [JM-0300-AA] + 1 Transformer</b>
<b>ORDER for EACH ZONE</b> - One JM-0300-AA Transformer Relay + One TruTemp or 24V Thermostat.
- 120v to the Transformer Relay -> supplies 24V to the thermostat.
- Call-for-heat: 24V through thermostat to the relay: relay closes providing 120V to the exhaust fan.
- Proving air switch at exhaust fan closes, supplying 120V to the heater zone transformer
- NOTE: The Transformer Relay does not directly energize the heaters in the system.
- A separate transformer sized at 40VA for 1st heater + 20VA for each additional heater in the zone is required to power the 24V heaters.

## General Information: All Tube Heater Models

### Ordering Tube Heater Kits

A tube heater can be ordered as a Complete Kit System, or by ordering the individual Burner and Tube Kits that comprise the system.

- Refer to the Complete Kit Systems listed for each model on the pages below, along with List Pricing for each system.
- The Burner and Tube Kit part numbers that comprise any Complete System are listed to the right of the Complete Systems.
- Part Numbers and Pricing for the Burner and Tube Kits are listed on the page following the Complete System listing

### Fuel Type and Field Conversion:

#### 1. Burner input capacities: 40,000, 45,000, 60,000, 80,000, 130,000 & 150,000 Btuh:

- All burners up to 150,000 Btuh [excluding 110,000] are produced and stocked for natural gas fuel.
- A Field Conversion Kit is required for conversion of burner to LP gas. See page 61 for a listing of Conversion Kits.

#### 2. Burner input capacities: 110,000, 175,000 & 200,000 Btuh:

- Field Conversion Kits available for 110,000, 175,000 & 200,000 burners, but conversion is more substantial than lower inputs.
- Order 110,000, 175,000 and 200,000 Tube Heater Systems for the appropriate fuel. See model price pages below for details

### Power Supply, and Line Voltage or 24 Vac Thermostat Control?

- All tube heater models have a 120Vac combustion air blower motor hence require 120Vac supplied to the burner.
- A step-down transformer [120/24Vac] provides 24Vac to ignition and gas controls and to a 24 Vac thermostat [field supplied].
- All tube heater models are factory ready for either a Line Voltage or 24Vac Thermostat.
- To control multiple tube heaters with one 24Vac Thermostat:
  - One heater is controlled by a 24Vac Thermostat
  - EACH additional heater requires a relay switch to close the thermostat terminals in the burner [see next page]

### Connecting a Tube Heater to the Gas Supply

- Tube heaters require a flexible gas connector for connection to the gas supply.
- All tube heater burners are supplied with a flexible gas connector for connection to the gas supply.
- All flexible gas connectors supplied are approved for indoor or outdoor use.

Note: Minimum length for tube heater flexible connector is 24 inches.

Refer to table below for correct sized connector that is supplied and must be installed.

Gas connector is shipped in the Burner Kit carton

Flexible Gas Connector	
Input Btuh	Required ID x Length
40,000 to 125,000	1/2" x 24"
150,000 to 200,000	3/4" x 36"

#### Flexible Gas Connectors:

##### Stainless Steel Flex - Replacement Parts

FLEXIBLE Connector 1/2" x 24" - for 40,000 up to 125,000 Btuh			
	JL-0771-XX	\$	59.00
FLEXIBLE Connector 3/4" x 36" - for 150,000 up to 200,000 Btuh			
	JL-0771-YY	\$	186.00

### High Altitude Application:

- Above 4,500 ft: REDUCE TOTAL SYSTEM LENGTH BY 20 FT [Total System = Air Duct + Tube + Vent].
- Refer to product manual for model details and orifice chart.

## 24 VOLT OPTION GUIDELINES

### TruTemp / 24V Thermostat / Patio Panel / Remote Control of Infrasave Tube Heaters

#### Infrasave TUBE HEATERS

**120Vac supply is ALWAYS required to the burner:** Powers the blower and the transformer in each burner assembly regardless of the thermostat or controller voltage.

**IMPORTANT: Models IQ, ITB, ITBU**

The Fenwal ignition control has a post-purge feature that purges the system when call-for-heat ends

For the post-purge feature to function, a 24V thermostat or control signal must be used

Line voltage control will disconnect power from the ignition control and disable the post-purge feature

#### TUBE HEATER 24V CONTROL OPTIONS:

Single TUBE HEATER per Single TruTemp / 24V THERMOSTAT / patioPanel switch\* / Remote Control

- Tube heaters are factory ready for 24Vac thermostat control
- 24V power to the thermostat is supplied by the transformer within the heater
- A 24V/120V relay switch [powers blower] is onboard the Fenwal Ignition Control, or is factory installed in the burner of Outdoor models that use a potted control

**\*ORDER - Any 24 volt thermostat or TruTemp supplied by Infrasave to control a single tube heater**

- **patioPanel:** 24V power to the panel switch is supplied from the transformer within the burner  
ONLY ONE tube heater can be controlled by each patioPanel switch
- **Remote Control:** Each Burner is ready for installation of Remote Control Receiver Kit: JP-1236-RK  
- Refer to patio heater section for information on Remote Control options

Multiple TUBE HEATERS per Single TruTemp / 24V THERMOSTAT / patioPanel switch\* / Remote Control

MULTIPLE HEATERS IN A COMMON ZONE: Requires Accessory: Relay Switch JS-0568-CC

- 120V supply is ALWAYS required to each burner to power the blower and transformer
- The first burner is controlled by connection of a 24V thermostat [or TruTemp, or other 24V power source]
- 24V power is provided to the thermostat by the transformer in the first burner
- Each additional burner in the zone requires an individual Relay Switch JS-0568-CC
- The Relay Switch is field mounted on or in the burner housing
- For outdoor application the Relay Switch must be mounted in a field supplied NEMA 4 enclosure, or inside the burner housing

**ORDER: 1ST Heater: 24V Thermostat [OR TruTemp] + ONE Relay Switch JS-0568-CC FOR EACH additional heater**

# RESIDENTIAL GARAGE / SHOP HEATER

## Compact Model P40-R

FACTORY ASSEMBLED SYSTEM INSTALLS DIRECTLY FROM CARTON

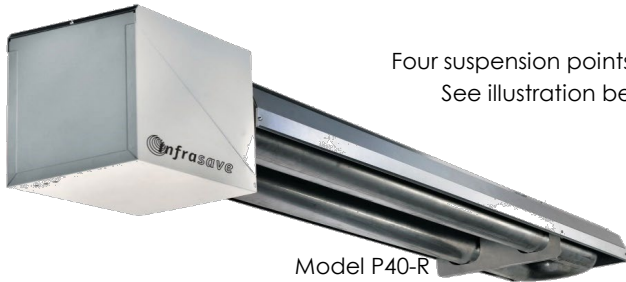

Four suspension points on top  
See illustration below

Compact 10 ft design  
Includes: 24 volt thermostat  
Hanging Chain  
Suspension Hooks

**BURNER: 40,000 Btuh Natural Gas [optional conversion kit for LPG], 120V 3-Pronged Plug, 24V Thermostat with 20 ft of 18/2 wire;**

**TUBE / REFLECTOR SYSTEM:** Corrosion resistant aluminized steel construction, 4 inch diameter U-tube provides 17 ft of heat exchange tube in compact 10 ft length; includes 4 ft Lion Chain and four safety snap hooks.

MODEL	CAPACITY	FUEL	LENGTH	PART #	LIST PRICE
P40-R	40,000 Btuh	NG	10'	PU-R040-BN	\$ 2,365.00

**FIELD CONVERSION KIT TO LPG - P40-R BURNER [Burners are produced in natural gas only]**

INPUT	PART #	LIST PRICE*
Field Conversion Kit NG to LP	JS-0555-XA	\$ 47.00

**OPTIONAL ACCESSORIES:**

4" Horizontal Wall Flue Terminal	JA-0528-XX	\$ 47.00
Flexible Gas Connector 1/2" x 24"	JL-0771-XX	59.00
<b>Protective Guard Screen</b>	JS-0502-UR-GK	310.00

- Zinc coated protection
- Required for installations between 6 to 8 ft above floor
- Two piece set, field installed, clips in to pre-made holes in reflector

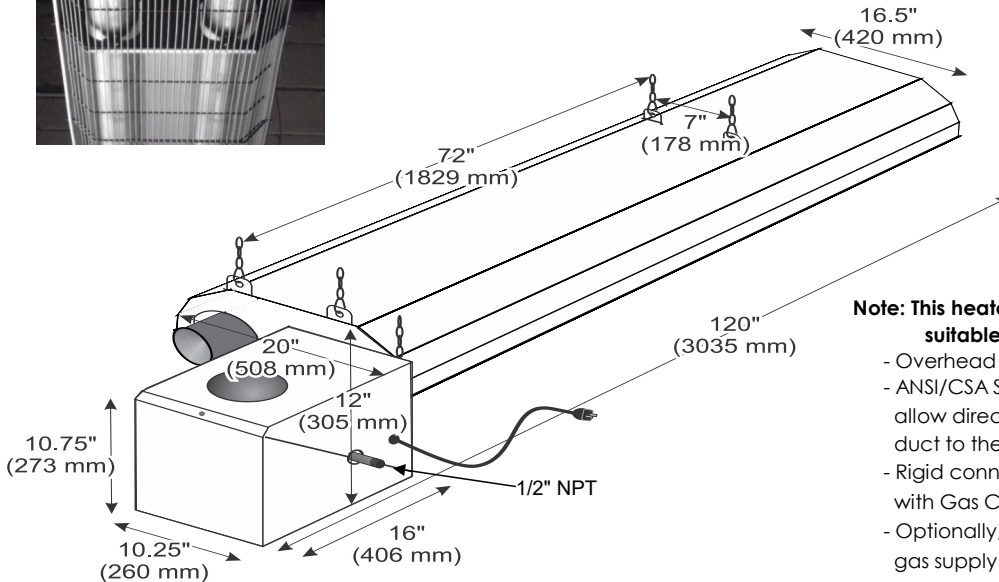
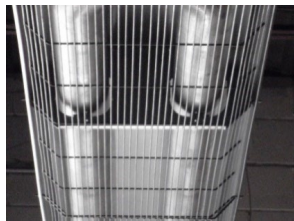

**Note: This heater is approved as a Vented Room Heater suitable for use in residential garage/shop**

- Overhead suspended type
- ANSI/CSA Standards and Code requirements do not allow direct connection of an outside combustion air duct to the heater
- Rigid connection to the gas supply is in compliance with Gas Code requirements
- Optionally, an installer may choose to connect to the gas supply using a metallic flexible gas connector
- Confirm gas connection requirements with local authority

## Indoor / Outdoor Commercial / Industrial Tube Heaters

### P40U-I, P40U-IP, P40U-IW

**P40U-I** Complements Premier IQ Series and Builder ITB Series Models

- Compact low input factory assembled heater for commercial / industrial applications

**P40U-IP & P40U-IW** round out the outdoor and harsh environment models IWP & IW

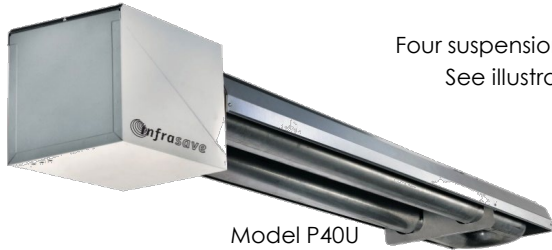

Model P40U

Four suspension points on top  
See illustration below

Compact 10 ft total length design  
Factory assembled burner to tube  
Installs directly from carton

For outdoor use:

- P40U-IP Powder Coated Housing
- P40U-IW Stainless Steel Housing

**BURNER: 40,000 Btuh Natural Gas [optional conversion kit for LPG], Flexible Gas Connector, 120V 3-Pronged Plug,**

4" dia. Combustion Air Collar.

**P40U-I:** Indoor; Painted burner housing with hinged lower panel and single fastener access for servicing

**P40U-IP, -IW:** Outdoor weather resistant burner housing for outdoor and harsh environments

**TUBE / REFLECTOR SYSTEM:** Corrosion resistant aluminized steel construction, 4 inch diameter U-tube provides 17 ft of heat exchange tube in compact 10 ft length; includes 4 ft Lion Chain and four safety snap hooks.

**COMPLETE SYSTEMS:**

MODEL	CAPACITY	FUEL	TOTAL LENGTH	Burner Housing	PART #	LIST PRICE
P40U-I	40,000 Btuh	NG	10'	Painted; Drop jaw access for service	PU-OJ40-AN	\$ 2,447.00
P40U-IP	40,000 Btuh	NG	10'-3"	Powder Coated weather resistant	PU-PJ40-AN	3,084.00
P40U-IW	40,000 Btuh	NG	10'-3"	Stainless Steel weather resistant	PU-WJ40-AN	3,456.00

**FIELD CONVERSION KIT FOR P40U-I [-IP, -IW] SERIES: Burners are produced in Natural Gas only**

Field Conversion Kit NG to LP	40,000 Btuh	JS-0555-XA	\$ 47.00
-------------------------------	-------------	------------	----------

**OPTIONAL ACCESSORIES:**

4" Horizontal Wall Flue Terminal	JA-0528-XX	47.00
----------------------------------	------------	-------

**Protective Guard Screen**

- Required for installations between 6 to 8 ft above floor JS-0502-UR-GK 310.00

- Zinc coated weather protection
- Recommended for Patio installations
- Two piece set, field installed, clips in to reflector

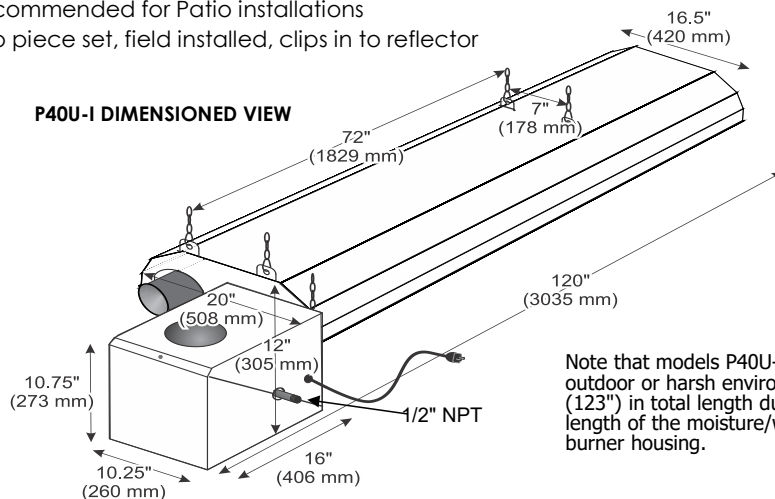
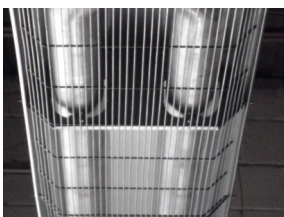

Note that models P40U-IP and P40U-IW for outdoor or harsh environment are 10'-3" (123") in total length due to the longer length of the moisture/weather resistant burner housing.



# IQ SERIES TUBE HEATERS

## PREMIER PERFORMANCE

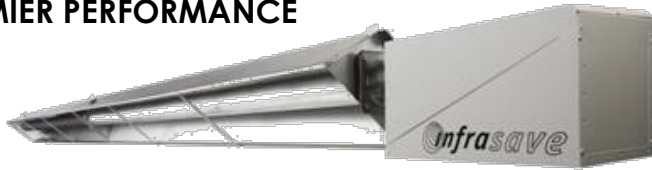

**IQ SERIES FEATURES:**

- 24V or Line Voltage Thermostat Ready
- Status Indicator Lights
- Power Cord with Plug
- Birdscreened Combustion Air Collar - 4"
- Swing-down Cabinet Service Access
- 'Focus Shield' Reflector & End Caps for Premier IR Heat Output
- Emissive Coated Radiant Tubes
- Factory Mounted Igniter
- Flexible Gas Connector included

Straight Tube - emissive coated

Plate hangers require 9'-8" o.c. positioning  
Suspend with chain, cable, or threaded rod

Supension points: 2 last tube + 1 other tubes; 50 ft heater has 6 suspension points

**COMPLETE TUBE HEATER SYSTEMS:**

OPTIONAL ACCESSORIES PAGES 30 to 33

**TO ORDER:** Use the SYSTEM KIT MODEL # or INDIVIDUAL BURNER & TUBE COMPONENT KITS

SYSTEM KIT MODEL #	CAPACITY INPUT [Btuh]	TUBE LENGTH	FUEL	COMPONENT KITS [individual cartons]			LIST PRICE
				Burner Kit #	Tube Kit 1 #	Tube Kit 2 #	
PU-0J40-AN	40,000	10'U	NG*				\$ 2,447.00
IQ-45-20-AN	45,000	20'	NG*	JJ-S045-AN	TS-1420-JZ	-	2,352.00
IQ-60-20-AN	60,000	20'	NG*	JJ-S060-AN	TS-1420-JZ	-	2,352.00
IQ-60-30-AN		30'		JJ-S060-AN	TS-1430-JZ	-	2,673.00
IQ-80-20-AN	80,000	20'	NG*	JJ-S080-AN	TS-1420-JZ	-	2,352.00
IQ-80-30-AN		30'		JJ-S080-AN	TS-1430-JZ	-	2,673.00
IQ-80-40-AN		40'		JJ-S080-AN	TS-1040-JZ	-	2,998.00
IQ-100-20-AN	100,000	20'	NG Only	JJ-S100-AN	TS-1020-JZ	-	2,506.00
IQ-110-30-AL	110,000	30'	LP **	JJ-S110-AL	TS-1430-JZ	-	2,673.00
IQ-110-30-AN		30'	NG*	JJ-S110-AN	TS-1430-JZ	-	2,673.00
IQ-110-40-AL		40'	LP **	JJ-S110-AL	TS-1040-JZ	-	2,998.00
IQ-110-40-AN		40'	NG*	JJ-S110-AN	TS-1040-JZ	-	2,998.00
IQ-110-50-AL		50'	LP **	JJ-S110-AL	TS-F030-JZ	TS-0020-JZ	3,460.00
IQ-110-50-AN		50'	NG*	JJ-S110-AN	TS-F030-JZ	TS-0020-JZ	3,460.00
IQ-130-30-AN	125,000	30'	NG ONLY	JJ-S130-AN	TS-1430-JZ	-	2,673.00
IQ-130-40-AN		40'	NG*	JJ-S130-AN	TS-1040-JZ	-	2,998.00
IQ-130-50-AN		50'		JJ-S130-AN	TS-F030-JZ	TS-0020-JZ	3,460.00
IQ-155-40-AN	150,000	40'	NG*	JJ-S155-AN	TS-1040-JZ	-	3,104.00
IQ-155-50-AN		50'		JJ-S155-AN	TS-F030-JZ	TS-0020-JZ	3,567.00
IQ-155-60-AN		60'		JJ-S155-AN	TS-F030-JZ	TS-0030-JZ	3,890.00
IQ-175-50-AL	175,000	50'	LP **	JJ-S175-AL	TS-1030-JZ	TS-0020-JZ	3,757.00
IQ-175-50-AN		50'	NG*	JJ-S175-AN	TS-1030-JZ	TS-0020-JZ	3,757.00
IQ-175-60-AL		60'	LP **	JJ-S175-AL	TS-1030-JZ	TS-0030-JZ	4,080.00
IQ-175-60-AN		60'	NG*	JJ-S175-AN	TS-1030-JZ	TS-0030-JZ	4,080.00
IQ-175-70-AN		70'	NG Only	JJ-S175-AN	TS-1030-JZ	TS-0040-JZ	4,402.00
IQ-200-50-AN	200,000	50'	NG Only	JJ-S200-AN	TS-1030-JZ	TS-0020-JZ	3,757.00
IQ-200-60-AL		60'	LP **	JJ-S200-AL	TS-1030-JZ	TS-0030-JZ	4,080.00
IQ-200-60-AN		60'	NG*	JJ-S200-AN	TS-1030-JZ	TS-0030-JZ	4,080.00
IQ-200-70-AL		70'	LP **	JJ-S200-AL	TS-1030-JZ	TS-0040-JZ	4,402.00
IQ-200-70-AN		70'	NG*	JJ-S200-AN	TS-1030-JZ	TS-0040-JZ	4,402.00

Tube Heater System ships in 2 or 3 cartons with Burner Kit + required Tube Kit[s] for heater length

\* Field conversion kits required for LP fuel are listed on page 61; \*\* Burner can be ordered LP see notes page 61

**HIGH ALTITUDE APPLICATION:** Above 4,500 ft Reduce Total System Length by 20 ft [Total System = Air Duct + Tube + Vent]. Refer to manual for model details and orifice chart.



**ORDERING TUBE HEATERS:**

**Order by Complete System: Order Kit Model # on previous page**

**Order by Burner and/or Tube Kits: Part #'s listed below can be ordered individually**

**Burner Kits: IQ Series - Can be ordered individually**

All burner assemblies operate on line voltage [120VAC], but are factory ready for 24Vac Thermostat control

BURNER KIT INCLUDES: FLEXIBLE GAS CONNECTOR, STATUS INDICATOR LIGHTS, ELECTRICAL CORD & PLUG, MOUNTED IGNITER, BIRDSCREENED 4" DIAMETER AIR INTAKE ADAPTER ON BLOWER.

<u>CAPACITY</u>	<u>MOUNTS TO TUBE LENGTHS</u>	<u>FUEL TYPE IN PRODUCTION</u>	<u>FLEX GAS CONNECTOR</u>	<u>PART #</u>	<u>LIST PRICE</u>
45,000 Btuh	20'	N.G.*	1/2" x 24"	JJ-S045-AN	\$ 1,415.00
60,000 Btuh	20', 30'	N.G.*	1/2" x 24"	JJ-S060-AN	1,415.00
80,000 Btuh	20', 30', 40'	N.G.*	1/2" x 24"	JJ-S080-AN	1,415.00
100,000 Btuh	20' special	N.G. ONLY	1/2" x 24"	JJ-S100-AN	1,415.00
110,000 Btuh	30', 40', 50'	N.G.*	1/2" x 24"	JJ-S110-AN	1,415.00
110,000 Btuh LP **	30', 40', 50'	LP **	1/2" x 24"	JJ-S110-AL	1,415.00
125,000 Btuh	30'	30 ft = N.G. ONLY	1/2" x 24"	JJ-S130-AN	1,415.00
125,000 Btuh	40', 50'	N.G.* [40' & 50' for NG or LP]	1/2" x 24"	JJ-S130-AN	1,415.00
150,000 Btuh	40', 50', 60'	N.G.*	3/4" X 36"	JJ-S155-AN	1,523.00
175,000 Btuh	50', 60', 70'	N.G.* [70' is NG Only]	3/4" X 36"	JJ-S175-AN	1,568.00
175,000 Btuh LP **	50', 60'	L.P.** [70' not available for LP]	3/4" X 36"	JJ-S175-AL	1,568.00
200,000 Btuh	50', 60', 70'	N.G.*	3/4" X 36"	JJ-S200-AN	1,568.00
200,000 Btuh LP **	LP: 60', 70'	L.P.** [50' not available for LP]	3/4" X 36"	JJ-S200-AL	1,568.00

\* Field conversion kits required for LP fuel are listed on page 61; \*\* Burner can be ordered LP see notes page 61

**Tube Kits: IQ Series - Can be ordered individually**

Tube Kits include Swaged Tubes, Reflectors, End Caps, Hangers, Tube Couplers and Turbulator[s] as required

**Stand-Alone Tube Kits [do not require any additional Tube Kit]**

		<u>TUBE KIT #</u>	<u>LIST PRICE</u>
<b>20': 45/60/80,000</b>	Flanged aluminized tube + 1 emissive coated steel tube: Turbulators 4 ft + 8 ft	TS-1420-JZ	\$ 937.00
<b>20': 100,000 ONLY</b>	Flanged aluminized tube + 1 emissive coated steel tube: Turbulator Special 8 ft	TS-1020-JZ	1,089.00
<b>30': 60/80/110/125,000</b>	Flanged aluminized tube + 1 aluminized tube + 1 emissive coated steel tube: Turbulators 5 ft + 8 ft [5 ft turbulator removed in field for 60 & 80,000]	TS-1430-JZ	1,260.00
<b>40': 80/110/125/150,000</b>	Flanged aluminized tube + 1 aluminized tube + 2 emissive coated steel tubes: Turbulators 2 ft + 10 ft	TS-1040-JZ	1,580.00

**Primary Tube Kits [require a Secondary Kit that assembles to create 50', 60' & 70' heaters]**

<b>30': 110/125/150,000</b>	Flanged aluminized tube + 1 aluminized tube + 1 emissive coated steel tube Turbulator 2 ft	TS-F030-JZ	1,243.00
<b>30': 175/200,000</b>	Flanged stainless steel tube + 1 aluminized tube + 1 emissive coated steel tube: Turbulators 4 ft + 6 ft [4 ft turbulator removed in field for 200,000 x 60 ft & 70 ft]	TS-1030-JZ	1,389.00

**Secondary Tube Kits [needed with above Primary Kits to make 50', 60' & 70' heaters]**

<b>20'</b>	Two emissive coated steel tubes [makes 50' heater with either 30' primary]	TS-0020-JZ	801.00
<b>30'</b>	Three emissive coated steel tubes [makes 60' heater with either 30' primary]	TS-0030-JZ	1,124.00
<b>40'</b>	Four emissive coated steel tubes [makes 70' heater with 30' primary TS-1030-JZ]	TS-0040-JZ	1,445.00
<b>10'</b>	One emissive coated steel tube, reflector, hanger, reflector braces, coupler Do not use the 10 ft tube kit to extend heater length beyond the maximum length approved for any input.	TS-1010-JZ	529.00



## ITB TUBE HEATERS BUILDER MARKET SERIES

Single Straight Tube - No emissive coat on tubes

Wire hangers allow flexible positioning along system

Suspend with chain, cable, or threaded rod; Suspension points: 2 per tube; e.g.: 40 ft heater has 8 suspension points

**BUILDER MODEL ITB FEATURES:**

- 24V or Line Voltage Thermostat Ready
- Birdscreened Combustion Air Collar - 4"
- Swing-down Cabinet Service Access
- Whisper Quiet Ceramic Burner
- End Capped Reflectors
- Flexible Gas Connector included

**COMPLETE TUBE HEATER SYSTEMS:**

OPTIONAL ACCESSORIES PAGES 30 to 33

**TO ORDER:** Use the **SYSTEM KIT MODEL #** or **INDIVIDUAL BURNER & TUBE COMPONENT KITS**

SYSTEM KIT MODEL #	CAPACITY INPUT [Btuh]	TUBE LENGTH	FUEL	COMPONENT KITS [individual cartons]			LIST PRICE
				Burner Kit #	Tube Kit 1 #	Tube Kit 2 #	
PU-OJ40-AN	40,000	10'U	NG*				\$ 2,447.00
ITB-45-20-AN	45,000	20'	NG*	JJ-E045-BN	TM-1420-SX	-	2,032.00
ITB-60-20-AN	60,000	20'	NG*	JJ-E060-BN	TM-1420-SX	-	2,032.00
ITB-60-30-AN		30'	NG*	JJ-E060-BN	TM-1430-SX	-	2,260.00
ITB-80-20-AN	80,000	20'	NG*	JJ-E080-BN	TM-1420-SX	-	2,032.00
ITB-80-30-AN		30'	NG*	JJ-E080-BN	TM-1430-SX	-	2,260.00
ITB-80-40-AN		40'	NG*	JJ-E080-BN	TM-1040-SX	-	2,487.00
ITB-100-20-AN	100,000	20'	NG Only	JJ-E100-BN	TM-1020-SX	-	2,260.00
ITB-110-30-AL	110,000	30'	LP **	JJ-E110-BL	TM-1430-SX	-	2,260.00
ITB-110-30-AN		30'	NG*	JJ-E110-BN	TM-1430-SX	-	2,260.00
ITB-110-40-AL		40'	LP **	JJ-E110-BL	TM-1040-SX	-	2,487.00
ITB-110-40-AN		40'	NG*	JJ-E110-BN	TM-1040-SX	-	2,487.00
ITB-110-50-AL		50'	LP **	JJ-E110-BL	TM-F030-SX	TM-0020-SX	2,892.00
ITB-110-50-AN		50'	NG	JJ-E110-BN	TM-F030-SX	TM-0020-SX	2,892.00
ITB-130-30-AN	125,000	30'	NG Only	JJ-E130-BN	TM-1430-SX	-	2,260.00
ITB-130-40-AN		40'	NG*	JJ-E130-BN	TM-1040-SX	-	2,487.00
ITB-130-50-AN		50'	NG*	JJ-E130-BN	TM-F030-SX	TM-0020-SX	2,892.00
ITB-155-40-AN	150,000	40'	NG*	JJ-E155-BN	TM-1040-SX	-	2,604.00
ITB-155-50-AN		50'	NG*	JJ-E155-BN	TM-F030-SX	TM-0020-SX	3,007.00
ITB-155-60-AN		60'	NG*	JJ-E155-BN	TM-F030-SX	TM-0030-SX	3,251.00
ITB-175-50-AL	175,000	50'	LP **	JJ-E175-BL	TM-1030-SX	TM-0020-SX	3,240.00
ITB-175-50-AN		50'	NG*	JJ-E175-BN	TM-1030-SX	TM-0020-SX	3,240.00
ITB-175-60-AL		60'	LP **	JJ-E175-BL	TM-1030-SX	TM-0030-SX	3,483.00
ITB-175-60-AN		60'	NG*	JJ-E175-BN	TM-1030-SX	TM-0030-SX	3,483.00
ITB-175-70-AN		70'	NG Only	JJ-E175-BN	TM-1030-SX	TM-0040-SX	3,729.00
ITB-200-50-AN	200,000	50'	NG Only	JJ-E200-BN	TM-1030-SX	TM-0020-SX	3,240.00
ITB-200-60-AL		60'	LP **	JJ-E200-BL	TM-1030-SX	TM-0030-SX	3,483.00
ITB-200-60-AN		60'	NG*	JJ-E200-BN	TM-1030-SX	TM-0030-SX	3,483.00
ITB-200-70-AL		70'	LP **	JJ-E200-BL	TM-1030-SX	TM-0040-SX	3,729.00
ITB-200-70-AN		70'	NG*	JJ-E200-BN	TM-1030-SX	TM-0040-SX	3,729.00

Tube Heater System ships in 2 or 3 cartons with Burner Kit + required Tube Kit[s] for heater length

\* Field conversion kits required for LP fuel are listed on page 61; \*\* Burner can be ordered LP see notes page 61

**HIGH ALTITUDE APPLICATION:** Above 4,500 ft Reduce Total System Length by 20 ft [Total System = Air Duct + Tube + Vent]. Refer to manual for model details and orifice chart.

**ORDERING TUBE HEATERS:**

**Order by Complete System: Order Kit Model # on previous page ... or**

**Order by Burner and/or Tube Kits: Part #'s listed below can be ordered individually**

**Burner Kits: ITB Series - Can be ordered individually**

All burner assemblies operate on line voltage [120VAC], but are factory ready for 24Vac Thermostat control

BURNER KIT INCLUDES: FLEXIBLE GAS CONNECTOR, BIRDSCREENED 4" DIAMETER AIR INTAKE ADAPTER ON BLOWER; IGNITER FIELD INSTALLED IN 1ST TUBE

<u>CAPACITY</u>	<u>MOUNTS TO TUBE LENGTHS</u>	<u>FUEL TYPE IN PRODUCTION</u>	<u>FLEX GAS CONNECTOR</u>	<u>PART #</u>	<u>LIST PRICE</u>
45,000 Btuh	20'	N.G.*	1/2" x 24"	JJ-E045-BN	\$ 1,219.00
60,000 Btuh	20', 30'	N.G.*	1/2" x 24"	JJ-E060-BN	1,219.00
80,000 Btuh	20', 30', 40'	N.G.*	1/2" x 24"	JJ-E080-BN	1,219.00
100,000 Btuh	20' special	N.G. ONLY	1/2" x 24"	JJ-E100-BN	1,219.00
110,000 Btuh	30', 40', 50'	N.G.*	1/2" x 24"	JJ-E110-BN	1,219.00
110,000 Btuh LP **	30', 40', 50'	LP **	1/2" x 24"	JJ-E110-BL	1,219.00
125,000 Btuh	30'	30 ft = N.G. ONLY	1/2" x 24"	JJ-E130-BN	1,219.00
125,000 Btuh	40', 50'	N.G.* [40' & 50' for NG or LP]	1/2" x 24"	JJ-E130-BN	1,219.00
150,000 Btuh	40', 50', 60'	N.G.*	3/4" X 36"	JJ-E155-BN	1,334.00
175,000 Btuh	50', 60', 70'	N.G.* [70' is NG Only]	3/4" X 36"	JJ-E175-BN	1,372.00
175,000 Btuh LP **	50', 60'	L.P.** [70' not available for LP]	3/4" X 36"	JJ-E175-BL	1,372.00
200,000 Btuh	50', 60', 70'	N.G.*	3/4" X 36"	JJ-E200-BN	1,372.00
200,000 Btuh LP **	LP: 60', 70'	L.P.** [50' not available for LP]	3/4" X 36"	JJ-E200-BL	1,372.00

\* Field conversion kits required for LP fuel are listed on page 61; \*\* Burner can be ordered LP see notes page 61

**Tube Kits: ITB Series - Can be ordered individually**

Tube Kits include Swaged Tubes, Reflectors, End Caps, Hangers, Tube Couplers and Turbulator[s] as required

**Stand-Alone Tube Kits [do not require any additional Tube Kit]**

		<u>TUBE KIT #</u>	<u>LIST PRICE</u>
<b>20': 45/60/80,000</b>	Flanged aluminized tube + 1 steel tube: Turbulators 4 ft + 8 ft	TM-1420-SX	\$ 814.00
<b>20': 100,000 ONLY</b>	Flanged aluminized tube + 1 steel tube: Turbulator Special 8 ft	TM-1020-SX	1,042.00
<b>30': 60/80/110/125,000</b>	Flanged aluminized tube + 1 aluminized tube + 1 steel tube: Turbulators 5 ft + 8 ft [5 ft turbulator removed in field for 60 & 80,000]	TM-1430-SX	1,042.00
<b>40': 80/110/125/150,000</b>	Flanged aluminized tube + 1 aluminized tube + 2 steel tubes: Turbulators 2 ft + 10 ft	TM-1040-SX	1,269.00

**Primary Tube Kits [require a Secondary Kit that assembles to create 50', 60' & 70' heaters]**

<b>30': 110/125/150,000</b>	Flanged aluminized tube + 1 aluminized tube + 1 steel tube; Turbulator 2 ft	TM-F030-SX	1,024.00
<b>30': 175/200,000</b>	Flanged stainless steel tube + 1 aluminized tube + 1 steel tube: Turbulators 4 ft + 6 ft [4 ft turbulator section removed in field for 200,000 x 60 ft & 70 ft]	TM-1030-SX	1,216.00

**Secondary Tube Kits [needed with above Primary Kits to make 50', 60' & 70' heaters]**

<b>20'</b>	Two steel tubes [makes 50' heater with either 30' primary]	TM-0020-SX	654.00
<b>30'</b>	Three steel tubes [makes 60' heater with either 30' primary]	TM-0030-SX	896.00
<b>40'</b>	Four steel tubes [makes 70' heater with 30' primary TS-1030-JZ]	TM-0040-SX	1,142.00
<b>10'</b>	One steel tube, reflector, hangers, tube coupler Do not use the 10 ft tube kit to extend heater length beyond the maximum length approved for any input.	TM-1010-SX	443.00



**BUILDER ITBU FEATURES:**

- 24V or Line Voltage Thermostat Ready
- Birdscreened Combustion Air Collar - 4"
- Swing-down Cabinet Service Access
- Whisper Quiet Ceramic Burner
- End Capped Reflectors
- Flexible Gas Connector included
- U-tube concentrates heat output
- Gas supply & vent at same end of heater

**ITBU SERIES TUBE HEATERS  
BUILDER MARKET SERIES**

Side-by-Side 'U' Tube - No emissive coat

Beam hangers allow flexible positioning along system

Suspend with chain, cable, or threaded rod at each end of beam hanger

Suspension points: 4 per double 10 ft tube section; e.g.: 20 ft 'U' heater has 8 suspension points

**COMPLETE TUBE HEATER SYSTEMS:**

OPTIONAL ACCESSORIES PAGES 30 to 33

**TO ORDER:** Use the **SYSTEM KIT MODEL #** or **INDIVIDUAL BURNER & TUBE COMPONENT KITS**

SYSTEM KIT MODEL #	CAPACITY INPUT [Btuh]	TUBE LENGTH FUEL	COMPONENT KITS [individual cartons]			LIST PRICE	
			Burner Kit #	Tube Kit 1 #	Tube Kit 2 #		
PU-0J40-AN	40,000	10' Total	NG*			\$ 2,447.00	
ITBU-60-10-AN	60,000	10'U = 2 x 10'	NG*	JJ-E060-BN	TM-1410-SU	-	2,274.00
ITBU-80-10-AN	80,000	10'U = 2 x 10'	NG*	JJ-E080-BN	TM-1410-SU	-	2,274.00
ITBU-80-15-AN		15'U = 2 x 15'		JJ-E080-BN	TM-1415-SU	-	2,660.00
ITBU-110-15-AN	110,000	15'U = 2 x 15'	NG*	JJ-E110-BN	TM-1415-SU	-	2,660.00
ITBU-110-15-AL		15'U = 2 x 15'	LP**	JJ-E110-BL	TM-1415-SU	-	2,660.00
ITBU-110-20-AN		20'U = 2 x 20'	NG*	JJ-E110-BN	TM-1020-SU	-	2,750.00
ITBU-110-20-AL		20'U = 2 x 20'	LP**	JJ-E110-BL	TM-1020-SU	-	2,750.00
ITBU-130-15-AN	125,000	15'U = 2 x 15'	NG Only	JJ-E130-BN	TM-1415-SU	-	2,660.00
ITBU-130-20-AN		20'U = 2 x 20'	NG*	JJ-E130-BN	TM-1020-SU	-	2,750.00
ITBU-155-20-AN	150,000	20'U = 2 x 20'	NG*	JJ-E155-BN	TM-1020-SU	-	2,866.00
ITBU-155-30-AN		30'U = 2 x 30'		JJ-E155-BN	TM-0020-SU	TM-0010-SU	3,483.00
ITBU-175-30-AN	175,000	30'U = 2 x 30'	NG*	JJ-E175-BN	TM-A120-SU	TM-0010-SU	3,732.00
ITBU-200-30-AN	200,000	30'U = 2 x 30'	NG*	JJ-E200-BN	TM-A120-SU	TM-0010-SU	3,732.00

NOTE: 180° Turn Box packed in Tube Kit 1 #

A Tube Heater System ships in 2 or 3 individual cartons with a Burner Kit + Tube Kit[s] required for heater length  
Burner Kits, and tube kits are packaged separately and clearly labelled for ease of assembling orders and shipment

\* Field conversion kits required for LP fuel are listed on page 61; \*\* Burner can be ordered LP see notes page 61

**HIGH ALTITUDE APPLICATION:** Above 4,500 ft Reduce Total System Length by 20 ft [Total System = Air Duct + Tube + Vent].  
Refer to manual for model details and orifice chart.

**ORDERING TUBE HEATERS:**

**Order by Complete System: Order Kit Model # on previous page ... or**

**Order by Burner and/or Tube Kits: Part #'s listed below can be ordered individually**

**Burner Kits: ITBU Series - Can be ordered individually**

All burner assemblies operate on line voltage [120VAC], but are factory ready for 24Vac Thermostat control

BURNER KIT INCLUDES: FLEXIBLE GAS CONNECTOR, BIRDSCREENED 4" DIAMETER AIR INTAKE ADAPTER ON BLOWER; IGNITER FIELD INSTALLED IN 1ST TUBE

<u>CAPACITY</u>	<u>MOUNTS TO TUBE LENGTHS</u>	<u>FUEL TYPE IN PRODUCTION</u>	<u>FLEX GAS CONNECTOR</u>	<u>PART #</u>	<u>LIST PRICE</u>
60,000 Btuh	10' U	N.G.*	1/2" x 24"	JJ-E060-BN	\$ 1,219.00
80,000 Btuh	10' U, 15' U	N.G.*	1/2" x 24"	JJ-E080-BN	1,219.00
110,000 Btuh	15' U, 20' U	N.G.*	1/2" x 24"	JJ-E110-BN	1,219.00
110,000 Btuh LP **	15' U, 20' U	LP **	1/2" x 24"	JJ-E110-BL	1,219.00
125,000 Btuh	15' U	N.G. Only	1/2" x 24"	JJ-E130-BN	1,219.00
125,000 Btuh	20' U	N.G.*		JJ-E130-BN	1,219.00
150,000 Btuh	20' U, 30' U	N.G.*	3/4" X 36"	JJ-E155-BN	1,334.00
175,000 Btuh NG	30' U	N.G. Only	3/4" X 36"	JJ-E175-BN	1,372.00
200,000 Btuh NG	30' U	N.G. Only	3/4" X 36"	JJ-E200-BN	1,372.00

\* Field conversion kits required for LP fuel are listed on page 61; \*\* Burner can be ordered LP see notes page 61

**Tube Kits: ITBU Series**

Tube Kits include Swaged Tubes, 180° Turn Box, Reflectors, End Caps, Hangers, Tube Couplers and Turbulator[s] as required

**Stand-Alone Tube Kits [do not require any additional Tube Kit]**

		<u>TUBE KIT #</u>	<u>LIST PRICE</u>
<b>10'U:</b> 60/80,000 Qty 2 x 10 ft tubes	Flanged aluminized tube + 1 steel tube; 180° Turn Box; Turbulators 4 ft + 10 ft	TM-1410-SU	\$ 1,056.00
<b>15'U:</b> 80/110/125,000 Qty 2 x 10 ft tubes + Qty 2 x 5 ft tubes	Flanged aluminized tube 10' + 1 steel tube 10' + 2 steel tube 5'; 180° Turn Box; Turbulators 4 ft + 10 ft	TM-1415-SU	1,442.00
<b>20'U:</b> 110/125/150,000 Qty 4 x 10 ft tubes	Flanged aluminized tube + 3 steel tube; 180° Turn Box; Turbulator 10 ft	TM-1020-SU	1,534.00

**For 30'U Tube Systems:** Primary Tube Kit + Secondary Tube Kit ship in separate cartons

**Order Both Tube Kit #'s:** 20 ft Primary Kit appropriate for input + 10 ft Secondary Kit to make 30'U-Tube heaters:

**Option 1: 150,000 x 30' U**

<b>20'U Primary Kit</b>	Flanged aluminized tube + 3 steel tube; 180° Turn Box	TM-0020-SU	1,495.00
<b>+ 10 ft Secondary Kit</b>	Needed with TM-0020-SU to make 30' U-Tube heaters	TM-0010-SU	654.00
Qty 6 x 10 ft tubes = 30' U Tube Assembly for 150,000 Burner			2,149.00

**Option 2: 175,000 or 200,000 x 30' U**

<b>20'U Primary Kit</b>	Flanged stainless steel tube + 1 aluminized tube + 2 steel tube; Turbulator 10 ft; 180° Turn Box	TM-A120-SU	\$ 1,709.00
<b>+ 10 ft Secondary Kit</b>	Needed with TM-A120-SU to make 30' U-Tube heaters	TM-0010-SU	654.00
Qty 6 x 10 ft tubes = 30' U Tube Assembly for 175,000 & 200,000 Burner			2,363.00



**MODEL ITT FEATURES:**

- 2-Stage burner operation (100%/70%)
- Birdscreened Combustion Air Collar - 4"
- Status indicator lights
- Swing-down Cabinet Service Access
- Whisper Quiet Ceramic Burner
- End Capped Reflectors
- Flexible Gas Connector included

**ITT SERIES - TWO STAGE**

[Single Straight Tube - No emissive coat]

Wire hangers allow flexible positioning along system

Suspend with chain, cable, or threaded rod; Suspension points: 2 per tube; e.g.: 40 ft heater has 8 suspension points

**COMPLETE TUBE HEATER SYSTEMS:**

OPTIONAL ACCESSORIES PAGES 30 to 33

**TO ORDER: Use the SYSTEM KIT MODEL # or INDIVIDUAL BURNER & TUBE COMPONENT KITS**

SYSTEM KIT MODEL #	CAPACITY INPUT [Btuh]	TUBE LENGTH	FUEL	COMPONENT KITS [individual cartons]			LIST PRICE
				Burner Kit #	Tube Kit 1 #	Tube Kit 2 #	
ITT-80-20-AN	80,000/60,000	20'	NG*	JJ-080T-BN	TM-1420-SX	-	\$ 2,189.00
ITT-80-30-AN		30'		JJ-080T-BN	TM-1430-SX	-	2,416.00
ITT-110-30-AN	110,000/75,000	30'	NG*	JJ-110T-BN	TM-1430-SX	-	2,416.00
ITT-110-30-AL		30'	LP**	JJ-110T-BL	TM-1430-SX	-	2,416.00
ITT-110-40-AN		40'	NG*	JJ-110T-BN	TM-1040-SX	-	2,644.00
ITT-110-40-AL		40'	LP**	JJ-110T-BL	TM-1040-SX	-	2,644.00
ITT-130-30-AN	125,000/90,000	30'	NG Only	JJ-130T-BN	TM-1430-SX	-	2,416.00
ITT-130-40-AN		40'	NG*	JJ-130T-BN	TM-1040-SX	-	2,644.00
ITT-155-40-AN	150,000/110,000	40'	NG*	JJ-155T-BN	TM-1040-SX	-	2,772.00
ITT-155-50-AN		50'		JJ-155T-BN	TM-F030-SX	TM-0020-SX	3,180.00
ITT-175-50-AN	175,000/125,000	50'	NG Only	JJ-175T-BN	TM-1030-SX	TM-0020-SX	3,423.00
ITT-175-60-AN		60'		JJ-175T-BN	TM-1030-SX	TM-0030-SX	3,666.00
ITT-200-50-AN	200,000/140,000	50'	NG Only	JJ-200T-BN	TM-1030-SX	TM-0020-SX	3,423.00
ITT-200-60-AN		60'		JJ-200T-BN	TM-1030-SX	TM-0030-SX	3,666.00

A Tube Heater System ships in 2 or 3 individual cartons with a Burner Kit + Tube Kit[s] required for heater length  
Burner Kits, and tube kits are packaged separately and clearly labelled for ease of assembling orders and shipment

\* Field conversion kits required for LP fuel are listed on page 61; \*\* Burner can be ordered LP see notes page 61

**HIGH ALTITUDE APPLICATION:** Above 4,500 ft Reduce Total System Length by 20 ft [Total System = Air Duct + Tube + Vent].  
Refer to manual for model details and orifice chart.

**THERMOSTAT CONTROL for Two Stage:**

	PART #	LIST PRICE*
Two Stage 24V Digital Thermostat	JS-0569-DT	\$ 360.00

**ORDERING TUBE HEATERS:**

Order by Complete System: Order Kit Model # on previous page ... or

Order by Burner and/or Tube Kits: Part #'s listed below can be ordered individually

**Burner Kits: 2-Stage ITT Series - Can be ordered individually**

All burner assemblies operate on line voltage [120VAC], but are factory ready for 24Vac 2-Stage Thermostat control

BURNER KIT INCLUDES: FLEXIBLE GAS CONNECTOR, BIRDSCREENED 4" DIAMETER AIR INTAKE ADAPTER ON BLOWER; IGNITER FIELD INSTALLED IN 1ST TUBE

<u>CAPACITY Btu/h</u>	<u>MOUNTS TO TUBE LENGTHS</u>	<u>FUEL TYPE IN PRODUCTION</u>	<u>FLEX GAS CONNECTOR</u>	<u>PART #</u>	<u>LIST PRICE</u>
80,000/60,000	20', 30'	N.G.*	1/2" x 24"	JJ-080T-BN	\$ 1,408.00
110,000/75,000	30', 40'	N.G.*	1/2" x 24"	JJ-110T-BN	\$ 1,408.00
110,000/75,000	30', 40'	LP**	1/2" x 24"	JJ-110T-BL	1,408.00
125,000/90,000	30'	N.G. ONLY	1/2" x 24"	JJ-130T-BN	1,408.00
125,000/90,000	40'	N.G.*	1/2" x 24"	JJ-130T-BN	1,408.00
150,000/110,000	40', 50'	N.G.*	3/4" X 36"	JJ-155T-BN	1,539.00
175,000/125,000	50', 60'	N.G. ONLY	3/4" X 36"	JJ-175T-BN	1,591.00
200,000/140,000	50', 60'	N.G. ONLY	3/4" X 36"	JJ-200T-BN	1,591.00

\* Field conversion kits required for LP fuel are listed on page 61; \*\* Burner can be ordered LP see notes page 61

**Tube Kits: ITT Series - Can be ordered individually**

Tube Kits include Swaged Tubes, Reflectors, End Caps, Hangers, Tube Couplers and Turbulator[s] as required

**Stand-Alone Tube Kits [do not require any additional Tube Kit]**

		<u>TUBE KIT #</u>	<u>LIST PRICE</u>
<b>20':</b> 80,000	Flanged aluminized tube + 1 steel tube; Turbulators 4 ft + 8 ft	TM-1420-SX	\$ 814.00
<b>30':</b> 80/110/125,000	Flanged aluminized tube + 1 aluminized tube + 1 steel tube; Turbulators 5 ft + 8 ft [5 ft turbulator removed in field for 60 & 80,000]	TM-1430-SX	1,042.00
<b>40':</b> 110/125/150,000	Flanged aluminized tube + 1 aluminized tube + 2 steel tubes; Turbulators 2 ft + 10 ft	TM-1040-SX	1,269.00

**Primary Tube Kits [require a Secondary Kit that assembles to create 50' & 60' heaters]**

<b>30':</b> 150,000	Flanged aluminized tube + 1 aluminized tube + 1 steel tube; Turbulator 2 ft	TM-F030-SX	1,024.00
<b>30':</b> 175/200,000	Flanged stainless steel tube + 1 aluminized tube + 1 steel tube; Turbulators 4 ft + 6 ft [4 ft turbulator section removed in field for 200,000 x 60 ft ]	TM-1030-SX	1,216.00

**Secondary Tube Kits [needed for above Primary Kits to make 50' & 60' heaters]**

<b>20'</b>	Two steel tubes [makes 50' heater with either 30' primary]	TM-0020-SX	654.00
<b>30'</b>	Three steel tubes [makes 60' heater with either 30' primary]	TM-0030-SX	896.00
<b>10'</b>	One steel tube, reflector, hangers, tube coupler	TM-1010-SX	443.00

Do not use the 10 ft tube kit to extend heater length beyond the maximum length approved for any input.





## ITTU SERIES - TWO STAGE

[Double Tube - No emissive coat]

Beam hangers allow flexible positioning along system

Suspend with chain, cable, or threaded rod at each end of beam hanger

Supension points: 4 per double 10 ft tube section; e.g.: 20 ft 'U' heater has 8 suspension points

### MODEL ITTU FEATURES:

- 2-Stage burner operation (100/70%)
- Birdscreened Combustion Air Collar - 4"
- Status indicator lights
- Swing-down Cabinet Service Access
- Whisper Quiet Ceramic Burner
- End Capped Reflectors
- Flexible Gas Connector included
- U-tube concentrates heat output
- Gas supply & vent at same end of heater

### COMPLETE TUBE HEATER SYSTEMS:

OPTIONAL ACCESSORIES PAGES 30 to 33

**TO ORDER:** Use the **SYSTEM KIT MODEL #** or **INDIVIDUAL BURNER & TUBE COMPONENT KITS**

SYSTEM KIT MODEL #	CAPACITY INPUT [Btuh]	TUBE		COMPONENT KITS [individual cartons]			LIST PRICE
		LENGTH	FUEL	Burner Kit #	Tube Kit 1 #	Tube Kit 2 #	
ITTU-80-10-AN	80,000/60,000	10'U =	2 x 10' NG*	JJ-080T-BN	TM-1410-SU	-	\$ 2,430.00
ITTU-80-15-AN		15'U =	2 x 15'	JJ-080T-BN	TM-1415-SU	-	2,819.00
ITTU-110-15-AN	110,000/75,000	15'U =	2 x 15' NG	JJ-110T-BN	TM-1415-SU	-	2,819.00
ITTU-110-15-AL		15'U =	2 x 15' LP**	JJ-110T-BL	TM-1415-SU	-	2,819.00
ITTU-110-20-AN	110,000/75,000	20'U =	2 x 20' NG	JJ-110T-BN	TM-1020-SU	-	2,908.00
ITTU-110-20-AL		20'U =	2 x 20' LP**	JJ-110T-BL	TM-1020-SU	-	2,908.00
ITTU-130-15-AN	125,000/90,000	15'U =	2 x 15' NG Only	JJ-130T-BN	TM-1415-SU	-	2,819.00
ITTU-130-20-AN		20'U =	2 x 20' NG*	JJ-130T-BN	TM-1020-SU	-	2,908.00
ITTU-155-20-AN	150,000/110,000	20'U =	2 x 20' NG*	JJ-155T-BN	TM-1020-SU	-	3,038.00
ITTU-155-30-AN		30'U =	2 x 30'	JJ-155T-BN	TM-0020-SU	TM-0010-SU	3,652.00
ITTU-175-30-AN	175,000/125,000	30'U =	2 x 30' NG Only	JJ-175T-BN	TM-A120-SU	TM-0010-SU	3,914.00
ITTU-200-30-AN	200,000/140,000	30'U =	2 x 30' NG Only	JJ-200T-BN	TM-A120-SU	TM-0010-SU	3,914.00

NOTE: 180° Turn Box packed in Tube Kit 1 #

\* Field conversion kits required for LP fuel are listed on page 61; \*\* Burner can be ordered LP see notes page 61

A Tube Heater System ships in 2 or 3 individual cartons with a Burner Kit + Tube Kit[s] required for heater length

Burner Kits, and tube kits are packaged separately and clearly labelled for ease of assembling orders and shipment

**HIGH ALTITUDE APPLICATION:** Above 4,500 ft Reduce Total System Length by 20 ft [Total System = Air Duct + Tube + Vent]. Refer to manual for model details and orifice chart.

### THERMOSTAT CONTROL for Two Stage:

Two Stage 24V Digital Thermostat

PART #	LIST PRICE*
JS-0569-DT	\$ 360.00



**ORDERING TUBE HEATERS:**

**Order by Complete System: Order Kit Model # on previous page ... or**

**Order by Burner and/or Tube Kits: Part #'s listed below can be ordered individually**

**2-Stage Burner Kits: ITTU Series - Can be ordered individually**

All burner assemblies operate on line voltage [120VAC], but are factory ready for 24Vac Thermostat control

BURNER KIT INCLUDES: FLEXIBLE GAS CONNECTOR, BIRDSCREENED 4" DIAMETER AIR INTAKE ADAPTER ON BLOWER; IGNITER FIELD INSTALLED IN 1ST TUBE

<u>CAPACITY</u>	<u>MOUNTS TO TUBE LENGTHS</u>	<u>FUEL TYPE IN PRODUCTION</u>	<u>FLEX GAS CONNECTOR</u>	<u>PART #</u>	<u>LIST PRICE</u>
80,000/60,000	10'U, 15'U	N.G.*	1/2" x 24"	JJ-080T-BN	\$ 1,408.00
110,000/75,000	15'U, 20'U	N.G.*	1/2" x 24"	JJ-110T-BN	1,408.00
110,000/75,000 LP **	15' U, 20' U	LP **	1/2" x 24"	JJ-110T-BL	1,408.00
125,000/90,000	15'U	N.G. Only	1/2" x 24"	JJ-130T-BN	1,408.00
125,000/90,000	20' U	N.G.*	1/2" x 24"	JJ-130T-BN	1,408.00
150,000/110,000	20'U, 30'U	N.G.*	3/4" X 36"	JJ-155T-BN	1,539.00
175,000/125,000	30'U	N.G. Only	3/4" X 36"	JJ-175T-BN	1,591.00
200,000/140,000	30'U	N.G. Only	3/4" X 36"	JJ-200T-BN	1,591.00

\* Field conversion kits required for LP fuel are listed on page 61; \*\* Burner can be ordered LP see notes page 61

**Tube Kits: ITTU Series - Can be ordered individually**

Tube Kits include Swaged Tubes, 180° Turn Box, Reflectors, End Caps, Hangers, Tube Couplers and Turbulator[s] as required

**Stand-Alone Tube Kits [do not require any additional Tube Kit]**

		<u>TUBE KIT #</u>	<u>LIST PRICE</u>
<b>10'U:</b> 80/60 Qty 2 x 10 ft tubes	Flanged aluminized tube + 1 steel tube; 180° Turn Box; Turbulators 4 ft + 10 ft	TM-1410-SU	\$ 1,056.00
<b>15'U:</b> 80/60, 110/75, 125/90 Qty 2 x 10 ft tubes + Qty 2 x 5 ft tubes	Flanged aluminized tube 10' + 1 steel tube 10' + 2 steel tube 5'; 180° Turn Box; Turbulators 4 ft + 10 ft	TM-1415-SU	1,442.00
<b>20'U:</b> 110/75, 125/90, 150/110 Qty 4 x 10 ft tubes	Flanged aluminized tube + 3 steel tube; 180° Turn Box; Turbulator 10 ft	TM-1020-SU	1,534.00

**For 30'U Tube Systems:** Primary Tube Kit + Secondary Tube Kit ship in separate cartons

**Order Both Tube Kit #'s: 20 ft Primary Kit** appropriate for input + **10 ft Secondary Kit** to make 30'U-Tube heaters:

**Option 1: 150,000/110,000 x 30' U**

<b>20'U Primary Kit</b>	Flanged aluminized tube + 3 steel tube; 180° Turn Box	TM-0020-SU	1,495.00
<b>+ 10 ft Secondary Kit</b>	Needed with TM-0020-SU to make 30' U-Tube heaters	TM-0010-SU	654.00
Qty 6 x 10 ft tubes = 30' U Tube Assembly for 150,000 Burner			2,149.00

**Option 2: 175,000/125,000 or 200,000/140,000 x 30' U**

<b>20'U Primary Kit</b>	Flanged stainless steel tube + 1 aluminized tube + 2 steel tube; Turbulator 10 ft; 180° Turn Box	TM-A120-SU	\$ 1,709.00
<b>+ 10 ft Secondary Kit</b>	Needed with TM-A120-SU to make 30' U-Tube heaters	TM-0010-SU	654.00
Qty 6 x 10 ft tubes = 30' U Tube Assembly for 175,000 & 200,000 Burner			2,363.00

# OPTIONAL ACCESSORIES - Page 1 of 3

INDOOR TUBE HEATER MODELS: IQ, ITB/U, ITT/U

Thermostats: Page 32

## Suspension Hardware:

Calculate Quantity {  
 Suspension Points: {  
 IQ Series: Total Tube Length divided by 10 plus 2 [(Tube Length/10) + 2]  
 ITB, ITT Models: Total Tube Length divided by 5 plus 1 [(heater tube length/5) + 1]

Calculate Chain: example: ITB x 40 ft heater located 3 ft below structural support = [(40/5) + 1] = 9 suspension points x 3 = 27 ft of chain

### Gripple Express™ ~ For indoor use only

- | No tools required for adjustment
- | Ready to use 10 ft cable length kit - loop one end
- | 100 lb work load

Package of 10

**PART #** **LIST PRICE**

JL-0800-GR-B \$ 301.00



### #2 Lion Chain - 115 lb work load - 200 ft roll

JL-0800-XX 175.00

### Safety Snap Hooks - 2"



Package of 24 JL-0800-SH 72.00

Package of 100 JL-0800-SH-B 220.00

### 'S' Hooks - 1 7/8"

Package of 25 JL-0798-SH 41.00

JL-0798-SH

### CLEARANCE TO COMBUSTIBLES SIGN

Metal sign - 18" x 6" - 3/4" red lettering  
 on white background

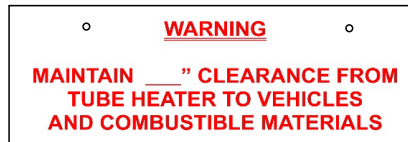

JL-0798-CS 67.00

## Elbow Kits: Install within the tube system

### Models IQ, IW, IWP Modular Elbow Kit:



#### 90° Aluminized Steel Elbow & Reflector Cover Kit [IQ, IW, IWP]:

[Elbow can be installed right or left hand - Includes coupler, reflector cover, hanger plate]

JS-0508-JZ \$ 284.00

#### 180° Elbow Kit [IQ, IW, IWP]: ORDER: TWO x 90° ELBOW KITS

Qty 2 x JS-0508-JZ 568.00

#### Û Reflector Angle Adapter - ONE REQUIRED AT EACH JUNCTURE of an angle change

JS-0504-JZ \$ 30.00

NOTE: The elbow reflector cap must always be in the horizontal plane - cap cannot be angle mounted  
 The Reflector Angle Adapter is required for angle mounting a reflector section before or after an elbow  
 Or for mounting of a reflector section at a different angle relative to the other reflectors in the system.

### ITB & ITT Series Elbow Kits: [These models do NOT have a reflector cover over the elbow]

#### ITB & ITT 90° Aluminized Steel Elbow Kit



JS-0508-SM \$ 212.00

S100 Elbow Kit includes: one elbow, one 4" tube coupler and two reflector end caps

#### ITB & ITT 180° Aluminized Steel Elbow Kit

- Order TWO x JS-0508-SM OR order Model S100U or SETU

Qty 2 x JS-0508-SM 424.00

#### 90° Elbow Kit [all superTube models]:

JS-0508-SST \$ 335.00

**OPTIONAL ACCESSORIES - Page 2 of 3**

**INDOOR TUBE HEATER MODELS: IQ, ITB/U, ITT/U**

Thermostats: Next page

**Combustion Air Intake Hood: *Optional***

All tube heater models have a 4" diameter collar on the blower or burner for 4" air duct attachment. Refer to I&O manual for complete details on venting and combustion air.



4" Outside Air Intake Wall Vent Hood ~ birdscreened

PART #	LIST PRICE
JS-0532-VC	\$ 34.00

**CAUTION:** In some climates hoarfrost can build on the birdscreen and cause heater malfunction on proving air switch. If your area experiences hoarfrost , use local solution for combustion air terminal.

Roof Vent [Rain Cap] Terminals supplied locally

**Vent Options:**



Horizontal / Wall Terminal\*

\* Fits single wall vent pipe - field crimp required to fit to double wall pipe

Use this termination cap by Infrasave or use an approved High Wind termination cap as supplied by others

**Roof Termination:** Use approved cap supplied by manufacturer of double-walled vent pipe

**Flue Vent Terminals:**

PART #	LIST PRICE
--------	------------

4" horizontal [through wall]

JA-0528-XX	\$ 47.00
------------	----------

6" horizontal

JA-0529-XX	57.00
------------	-------

Vent Tee 4" X 4" X 6"  
[Two couplers JA-0516-AA are optional]

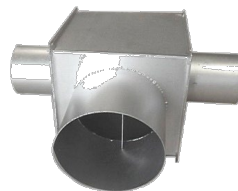

4" x 4" x 6"  
Vent Tee

JA-0514-XX	234.00
------------	--------

Optional Couplers for Vent Tee:  
4" x 8" Aluminized Steel Coupler with 2 x U-bolts

JA-0516-AA	78.00
------------	-------

**Decorative 'Tuxedo' Grille Kit - IQ, IW, IWP Models Only**

Dress up your tube heater installations.

- q Showrooms
- q Retail areas
- q Any area requiring a more refined 'look'



Matte black grille & aluminized steel framing secures with tabs to 'JZ' Series heater reflectors. [Not for ITB & ITT Series]

Decorative 'Tuxedo' Grille Kit - 10 ft - Matte Black Grille	Each 10 foot section	TG-0010-KT	\$ 638.00
---	----------------------	------------	-----------

<b>Reflector Side Extension</b> - All models - 10" deep x 116" long c/w Qty 3 x 'S' hooks		JS-0509-KT	86.00
---	--	------------	-------

**Tube Protection Screen** - 5 ft length  
[1/2" x 1/2" galvanized screen]  
[custom order: longer lead time]

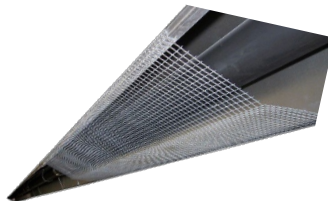

<b>Models: IQ, IW, IWP</b>	JA-0780-XX	157.00
----------------------------	------------	--------

<b>Models: ITB, ITT</b>	JA-0780-XS	157.00
-------------------------	------------	--------

**THERMOSTATS & CONTROL OPTIONS - next page**

## OPTIONAL ACCESSORIES - Page 3 of 3

### THERMOSTATS & CONTROLS

Tube heaters are "factory ready" for line voltage or 24Vac thermostat control

**IMPORTANT: Models IQ, ITB with Fenwal Ignition Control**

The Fenwal ignition control has a post-purge feature that purges the system when call-for-heat ends

For the post-purge feature to function, a 24V thermostat or 24V control signal must be used

Line voltage control will disconnect power from the ignition control and disable the post-purge feature

Multiple heaters in 24 volt thermostat zone require option JS-0568-CC [see below]

TruTemp Infrared Setback Thermostat  
 24Vac; °F & °C scales  
 BEST thermostat control for IR heaters  
 Enables all features of the ignition control



JM-0150-XX \$ 251.00

Saves up to an additional 15%  
 See more detail on the TruTemp next page

Line Voltage Thermostat [°F & °C Scales]  
 Note: Line voltage control disables the Post Purge  
 feature of the ignition control  
 Use 24Vac Thermostat for Post Purge



JL-0772-XX \$ 70.00

Low Voltage [24V] Digital Thermostat [°F / °C Selectable]  
 Note: Low voltage control enables all features  
 of the ignition control



JS-0569-WR \$ 118.00

Moisture Proof Thermostat [NEMA 4X enclosure]



JS-0570-XX \$ 162.00

### MULTIPLE HEATER - 24 VOLT CONTROL OPTIONS:

Control Multiple Tube Heaters in a common zone with one 24V Thermostat [wired to 1st heater]:

Each Additional heater requires 1 x 24V Relay Switch

JS-0568-CC \$ 32.00

- ✓ FIELD INSTALLED ON EXTERIOR OR INTERIOR OF BURNER HOUSING
- ✓ ONE REQUIRED FOR EACH BURNER EXCEPT THE FIRST ONE IN A ZONE  
 FIRST BURNER IS CONTROLLED BY 24V THERMOSTAT  
 [E.G.: A ZONE WITH 4 HEATERS REQUIRES: 1 x 24V Thermostat + 3 x Relay Switches]



- ✓ Refer to 24V Guidelines on page 11, and/or the I&O Manual wiring diagram for the heater model

### 2-STAGE THERMOSTAT CONTROL:

Two Stage 24V Digital Thermostat

JS-0569-DT \$ 360.00

# TRUTEMP

## Infrared Setback Thermostat



**TruTemp INFRARED SETBACK THERMOSTAT**

NOT FOR USE IN WET ENVIRONMENTS

The only infrared thermostat that senses and averages radiant and ambient temperatures for true comfort control and efficient heating system operation. An automatic setback feature further adds to fuel savings when the building is unoccupied. TruTemp thermostat can be used in conjunction with all Infrasave indoor heaters. 4" Diameter hemisphere fits standard electrical box

<u>MODEL</u>	<u>VOLTAGE</u>	<u>PART #</u>	<u>LIST PRICE</u>
TruTemp Thermostat	24 volts ac	JM-0150-XX	\$ 251.00

**FIELD MOUNTED OPTIONS REQUIRED WITH TruTemp THERMOSTAT**

- For each SINGLE TUBE HEATER controlled by SINGLE TruTemp

<u>ORDER</u>	<u>PART #</u>
1 TruTemp Thermostat	JM-0150-XX

- For MULTIPLE TUBE HEATERS controlled by SINGLE TruTemp

Control Multiple Tube Heaters in a common zone with one 24V TruTemp [wired to 1st heater]:

Each Additional heater requires 1 x 24V Relay Switch	JS-0568-CC	\$ 32.00
--	------------	----------

- n FIELD INSTALLED ON EXTERIOR OR INTERIOR OF BURNER HOUSING
- n ONE REQUIRED FOR EACH BURNER EXCEPT THE FIRST ONE IN A ZONE  
FIRST BURNER IS CONTROLLED BY 24V TruTemp  
[E.G.: A ZONE WITH 4 HEATERS REQUIRES: 1 x 24V Thermostat + 3 x Relay Switches]
- n Refer to 24V Guidelines on page 11, and/or the I&O Manual wiring diagram



- HIGH INTENSITY HEATERS with EXHAUST FAN controlled by SINGLE TruTemp per ZONE

**ORDER TruTemp plus this item:**

1	Transformer/Relay [field mounted]
---	--------------------------------------

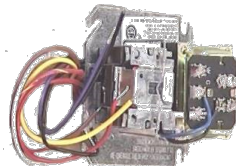

<u>PART #</u>	<u>LIST PRICE</u>
JM-0300-AA	\$ 194.00

**SECURITY OPTION TO PREVENT UNAUTHORIZED TAMPERING WITH TruTemp SETTINGS**

Two S/S Tamperproof Screws and One Tool [Order for the first TruTemp on project]	JM-0180-XX	\$ 104.00
Two S/S Tamperproof Screws [Order for each TruTemp on project]	JM-0180-AA	11.00

## ARENA SPECTATOR 'COMFORT' HEATING

Contact Infrasave Design for Arena Heating: Fax 1-866-724-9265; design@infrasave.com

## Infrasave ARENA CONTROL PANEL

ARENA CONTROL PANEL IS USED TO CONTROL THE DURATION OF OPERATION OF Infrasave HEATERS IN ARENA SPECTATOR HEATING, OR OTHER APPLICATIONS WHERE MULTI-ZONE DURATION CONTROL IS REQUIRED.

Includes: A master timer that can be adjusted by the operator for the desired duration of heating system operation;  
 A master on/off switch with status light;  
 The quantity of switches with status lights to match the number of zones/heaters being installed  
 All components mounted on an 11" x 13" x 4" deep control box with hinged front panel.  
 Also included separately is a transformer relay [field installation required] to power the arena panel.  
 Not included is any 120/24 volt transformer required to power high intensity heaters [refer to page 11 for 24V Transformer sizing and pricing].

**NOTE: Indicate the number of heating zones required when ordering an Arena Panel.**  
**For arena applications, Infrasave recommends one [or at most two] heaters per zone.**  
**For extraordinary projects contact Infrasave.**

	<u>MODEL</u>	<u>NUMBER OF HEATERS</u>		<u>PART #</u>	<u>LIST PRICE</u>
		<u>or ZONES</u>			
ARENA CONTROL PANELS	ACPT- 8	up to	8	JM-0408-XX	\$ 2,036.00
	ACPT-12	up to	12	JM-0412-XX	2,191.00
	ACPT-16	up to	16	JM-0416-XX	2,390.00



- Outdoor Patio Heating
- Wash Bay Applications
- Wet & Harsh Environment
- Food Industry Applications

#### Four Models to suit the application and environment: Three Models with Single or 2-Stage Burners

##### **IWP Series: Single Stage Burner with Powder Coated Cabinet**

##### **IWP2 Series: Two-Stage Burner with Powder Coated Cabinet**

- ✓ Preferred model for covered and enclosed patio areas; most economical solution
- ✓ Fresh air adapter and cap for 'outside' combustion air
- ✓ Weather tight powder coated burner cabinet
- ✓ Moisture resistant spark ignition package
- ✓ Designer color blends with patio aesthetics
- ✓ Tough, durable finish
- ✓ Best choice for patios, outdoor, wash bays and damp environments
- ✓ Aluminized steel: reflectors and tubes

##### **IW Series: Single Stage Burner with Stainless Steel Cabinet**

##### **IW2 Series: Two-Stage Burner with Stainless Steel Cabinet**

- ✓ Preferred model for harsh environments
- ✓ Recommended for use in harsh environment applications: Car & truck power washes
- ✓ Weather tight stainless steel burner cabinet
- ✓ Fresh air adapter and cap for 'outside' combustion air
- ✓ Aluminized steel: reflectors and tubes
- ✓ Moisture resistant spark ignition package

##### **IWS Series: Single-stage Burner with Stainless Steel Housing, Tubes, & Reflectors**

##### **IW2S Series: 2-Stage Burner with Stainless Steel Housing, Tubes, & Reflectors**

- ✓ Use ONLY where 'Stainless' is a necessity -> highly corrosive or food industry applications
- ✓ Stainless steel reflectors and stainless steel tubes
- ✓ Weather tight stainless steel burner cabinet
- ✓ Moisture resistant ignition control
- ✓ Fresh air adapter and cap for 'outside' combustion air
- ✓ Moisture resistant spark ignition package
- ✓ Fresh air adapter and cap for 'outside' combustion air
- ✓ NOTE: Stainless steel tubing has a lower emissivity value than aluminized steel tube
  - Less infrared heat output than other harsh environment models
  - Use the 'next size up' heater for infrared output equivalency to IW or IWP

##### **P40U-IP, -IW Series: Single Stage only; Factory Assembled, Installs Directly from Carton**

- ✓ Compact 'U'-Tube with 40,000 Btuh burner is 10'-3" total length
- ✓ P40U-IP has powder coated burner cabinet
- ✓ P40U-IW with stainless steel burner cabinet



# Single Stage IWP Series

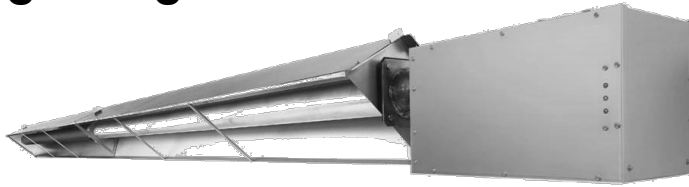

**IWP FEATURES:**

- 24V or Line Voltage Thermostat Ready
- Status Indicator Lights
- Power Cord with Plug
- Birdscreened 4" Combustion Air Collar and Intake Wall Hood
- Whisper Quiet Ceramic Burner
- 'Focus Shield' Reflector & End Caps for Premier IR Heat Output
- Emissive Coated Radiant Tubes
- Flexible Gas Connector included
- Factory Mounted Igniter

**PATIO, OUTDOOR, & WASH BAY**

- Powder Coated Weather Tight Burner Cabinet
- Aluminized Steel Tubes & Reflectors

**COMPLETE TUBE HEATER SYSTEMS:**

OPTIONAL ACCESSORIES PAGES 48 & 49

SYSTEM KIT MODEL #	CAPACITY INPUT [Btuh]	TUBE LENGTH	FUEL	SYSTEM COMPONENT KITS [individual cartons]			LIST PRICE
				Burner Kit #	Tube Kit 1 #	Tube Kit 2 #	
PU-PJ40-AN	40,000	10'U	NG*				\$ 3,084.00
IWP-45-20-AN	45,000	20'	NG*	JJ-045W-BN	TW-1420-JZ	-	3,073.00
IWP-60-20-AN	60,000	20'	NG*	JJ-060W-BN	TW-1420-JZ	-	3,073.00
IWP-60-30-AN		30'		JJ-060W-BN	TW-1430-JZ	-	3,400.00
IWP-80-20-AN	80,000	20'	NG*	JJ-080W-BN	TW-1420-JZ	-	3,073.00
IWP-80-30-AN		30'		JJ-080W-BN	TW-1430-JZ	-	3,400.00
IWP-80-40-AN		40'		JJ-080W-BN	TW-1040-JZ	-	3,776.00
IWP-110-30-AN	110,000	30'	NG*	JJ-110W-BN	TW-1430-JZ	-	3,400.00
IWP-110-30-AL		30'	LP**	JJ-110W-BL	TW-1430-JZ	-	3,400.00
IWP-110-40-AN		40'	NG*	JJ-110W-BN	TW-1040-JZ	-	3,776.00
IWP-110-40-AL		40'	LP**	JJ-110W-BL	TW-1040-JZ	-	3,776.00
IWP-110-50-AN		50'	NG*	JJ-110W-BN	TW-F030-JZ	TW-0020-JZ	4,270.00
IWP-110-50-AL		50'	LP**	JJ-110W-BL	TW-F030-JZ	TW-0020-JZ	4,270.00
IWP-130-30-AN	125,000	30'	NG Only	JJ-130W-BN	TW-1430-JZ	-	3,400.00
IWP-130-40-AN		40'	NG*	JJ-130W-BN	TW-1040-JZ	-	3,776.00
IWP-130-50-AN		50'	NG*	JJ-130W-BN	TW-F030-JZ	TW-0020-JZ	4,270.00
IWP-155-40-AN	150,000	40'	NG*	JJ-155W-BN	TW-1040-JZ	-	3,904.00
IWP-155-50-AN		50'		JJ-155W-BN	TW-F030-JZ	TW-0020-JZ	4,398.00
IWP-155-60-AN		60'		JJ-155W-BN	TW-F030-JZ	TW-0030-JZ	4,739.00
IWP-175-50-AL	175,000	50'	LP**	JJ-175W-BL	TW-1030-JZ	TW-0020-JZ	4,679.00
IWP-175-50-AN		50'	NG*	JJ-175W-BN	TW-1030-JZ	TW-0020-JZ	4,679.00
IWP-175-60-AL		60'	LP**	JJ-175W-BL	TW-1030-JZ	TW-0030-JZ	5,020.00
IWP-175-60-AN		60'	NG*	JJ-175W-BN	TW-1030-JZ	TW-0030-JZ	5,020.00
IWP-175-70-AN		70'	NG Only	JJ-175W-BN	TW-1030-JZ	TW-0040-JZ	5,382.00
IWP-200-50-AN	200,000	50'	NG Only	JJ-200W-BN	TW-1030-JZ	TW-0020-JZ	4,679.00
IWP-200-60-AL		60'	LP**	JJ-200W-BL	TW-1030-JZ	TW-0030-JZ	5,020.00
IWP-200-60-AN		60'	NG*	JJ-200W-BN	TW-1030-JZ	TW-0030-JZ	5,020.00
IWP-200-70-AL		70'	LP**	JJ-200W-BL	TW-1030-JZ	TW-0040-JZ	5,382.00
IWP-200-70-AN		70'	NG*	JJ-200W-BN	TW-1030-JZ	TW-0040-JZ	5,382.00

\* Field conversion kits required for LP fuel are listed on page 61; \*\* Burner can be ordered LP see notes page 61

A Tube Heater System ships in 2 or 3 individual cartons with a Burner Kit + Tube Kit[s] required for heater length  
Burner Kits, and tube kits are packaged separately and clearly labelled for ease of assembling orders and shipment

**HIGH ALTITUDE APPLICATION:** Above 4,500 ft Reduce Total System Length by 20 ft [Total System = Air Duct + Tube + Vent].  
Refer to manual for model details and orifice chart.



**ORDERING TUBE HEATERS:**

**Order by Complete System: Order Kit Model # on previous page ... or**

**Order by Burner and/or Tube Kits: Part #'s listed below can be ordered individually**

**Burner Kits: IWP Series - Powder Coated Burner Housing**

- Can be ordered individually

All burner assemblies operate on line voltage [120VAC], but are factory ready for 24Vac Thermostat control

BURNER KIT INCLUDES: FLEXIBLE GAS CONNECTOR, STATUS INDICATOR LIGHTS, ELECTRICAL CORD & PLUG, MOUNTED IGNITER, BIRDSCREENED 4" DIAMETER AIR INTAKE ADAPTER ON BLOWER.

<u>CAPACITY</u>	<u>MOUNTS TO TUBE LENGTHS</u>	<u>FUEL TYPE IN PRODUCTION</u>	<u>FLEX GAS CONNECTOR</u>	<u>PART #</u>	<u>LIST PRICE</u>
45,000 Btuh	20'	N.G.*	1/2" x 24"	JJ-045W-BN	\$ 2,038.00
60,000 Btuh	20', 30'	N.G.*	1/2" x 24"	JJ-060W-BN	2,038.00
80,000 Btuh	20', 30', 40'	N.G.*	1/2" x 24"	JJ-080W-BN	2,038.00
110,000 Btuh	30', 40', 50'	N.G.*	1/2" x 24"	JJ-110W-BN	2,038.00
110,000 Btuh LP **	30', 40', 50'	L.P.**	1/2" x 24"	JJ-110W-BL	2,038.00
125,000 Btuh	30'	N.G. Only	1/2" x 24"	JJ-130W-BN	2,038.00
125,000 Btuh	40', 50'	N.G.*	1/2" x 24"	JJ-130W-BN	2,038.00
150,000 Btuh	40', 50', 60'	N.G.*	3/4" X 36"	JJ-155W-BN	2,167.00
175,000 Btuh	50', 60', 70'	N.G.* [70' is NG Only]	3/4" X 36"	JJ-175W-BN	2,220.00
175,000 Btuh LP **	50', 60'	L.P.**	3/4" X 36"	JJ-175W-BL	2,220.00
200,000 Btuh	50', 60', 70'	N.G.*	3/4" X 36"	JJ-200W-BN	2,220.00
200,000 Btuh LP **	60', 70'	L.P.**	3/4" X 36"	JJ-200W-BL	2,220.00

\* Field conversion kits required for LP fuel are listed on page 61; \*\* Burner can be ordered LP see notes page 61

**Aluminized Steel Tube Kits: IWP Series**

- Can be ordered individually

ALL Tubes are Aluminized Steel Swaged, Aluminized Reflectors, End Caps, Hangers, Tube Couplers and Turbulator[s]

**Stand-Alone Tube Kits [do not require any additional Tube Kit]**

		<u>TUBE KIT #</u>	<u>LIST PRICE</u>
<b>20':</b> 45/60/80,000	Aluminized steel: Flanged tube + 1 emissive coated tube: Turbulators 4 ft + 8 ft	TW-1420-JZ	\$ 1,034.00
<b>30':</b> 60/80/110/125,000	Flanged aluminized steel tube + 2 emissive coated aluminized tubes: Turbulators 5 ft + 8 ft [5 ft turbulator removed in field for 60 & 80,000]	TW-1430-JZ	1,362.00
<b>40':</b> 80/110/125/150,000	Flanged Aluminized steel tube + 3 emissive coated aluminized tubes Turbulators 2 ft + 10 ft	TW-1040-JZ	1,738.00

**Primary Tube Kits** [require a Secondary Kit to make 50', 60' & 70' heaters]

<b>30':</b> 110/125/150,000	Aluminized steel: Flanged tube + 2 emissive coated tubes: Turbulator 2 ft	TW-F030-JZ	1,323.00
<b>30':</b> 175/200,000	Flanged stainless tube + 1 aluminized steel tube + 1 emissive coated aluminized tube: Turbulator 10 ft	TW-1030-JZ	1,552.00

**Secondary Tube Kits** [needed for above Primary Kits to make 50', 60' & 70' heaters]

<b>20'</b>	Two emissive coated aluminized tubes [makes 50' heater with either 30' primary]	TW-0020-JZ	909.00
<b>30'</b>	Three emissive coated aluminized tubes [makes 60' heater with either 30' primary]	TW-0030-JZ	1,251.00
<b>40'</b>	Four emissive coated aluminized tubes [makes 70' heater with 30' primary TW-1030-JZ]	TW-0040-JZ	1,612.00
<b>10'</b>	One emissive coated aluminized tube, reflector, reflector braces, hanger, tube coupler Do not use the 10 ft tube kit to extend heater length beyond the maximum length approved for any input.	TW-1010-JZ	563.00

## Two-Stage IWP2 Series

### PATIO, OUTDOOR, & WASH BAY

- Powder Coated Weather Tight Burner Cabinet
- Aluminized Steel Tubes & Reflectors

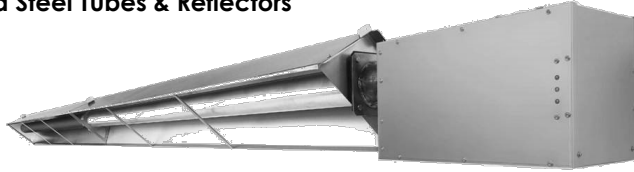

#### IWP2 FEATURES:

- 2-Stage Operation
- 24V Thermostat Ready
- Status Indicator Lights
- Power Cord with Plug
- Birdscreened 4" Combustion Air Collar and Intake Wall Hood
- 'Focus Shield' Reflector & End Caps for Premier IR Heat Output
- Emissive Coated Radiant Tubes
- Flexible Gas Connector included
- Factory Mounted Igniter

#### COMPLETE TUBE HEATER SYSTEMS:

OPTIONAL ACCESSORIES PAGES 48 & 49

SYSTEM KIT MODEL #	CAPACITY INPUT [Btuh]	TUBE		SYSTEM COMPONENT KITS [individual cartons]			LIST PRICE
		LENGTH	FUEL	Burner Kit #	Tube Kit 1 #	Tube Kit 2 #	
IWP2-80-20-AN	78/58,000	20'	NG*	JJ-TW08-BN	TW-1420-JZ	-	\$ 3,239.00
IWP2-80-30-AN		30'	NG*	JJ-TW08-BN	TW-1430-JZ	-	3,564.00
IWP2-110-30-AN	110/80,000	30'	NG*	JJ-TW11-BN	TW-1430-JZ	-	3,564.00
IWP2-110-30-AL	108/70,000	30'	LP**	JJ-TW11-BL	TW-1430-JZ	-	3,564.00
IWP2-110-40-AN		40'	NG*	JJ-TW11-BN	TW-1040-JZ	-	3,943.00
IWP2-110-40-AL		40'	LP**	JJ-TW11-BL	TW-1040-JZ	-	3,943.00
IWP2-130-30-AN	120/85,000	30'	NG Only	JJ-TW13-BN	TW-1430-JZ	-	3,564.00
IWP2-130-40-AN		40'	NG*	JJ-TW13-BN	TW-1040-JZ	-	3,943.00
IWP2-155-40-AN	150/110,000	40'	NG*	JJ-TW15-BN	TW-1040-JZ	-	4,070.00
IWP2-155-50-AN		50'	NG*	JJ-TW15-BN	TW-F030-JZ	TW-0020-JZ	4,565.00
<b>175 &amp; 200 Models not suitable for patio application</b>							
IWP2-175-50-AN	162/115,000	50'	NG Only	JJ-TW17-BN	TW-1030-JZ	TW-0020-JZ	\$ 4,843.00
IWP2-175-60-AN		60'	NG Only	JJ-TW17-BN	TW-1030-JZ	TW-0030-JZ	5,186.00
IWP2-200-50-AN	195/140,000	50'	NG Only	JJ-TW20-BN	TW-1030-JZ	TW-0020-JZ	4,843.00
IWP2-200-60-AN		60'	NG Only	JJ-TW20-BN	TW-1030-JZ	TW-0030-JZ	5,186.00

\* Field conversion kits required for LP fuel are listed on page 61; \*\* Burner can be ordered LP see notes page 61

A Tube Heater System ships in 2 or 3 individual cartons with a Burner Kit + Tube Kit[s] required for heater length Burner Kits, and tube kits are packaged separately and clearly labelled for ease of assembling orders and shipment

**HIGH ALTITUDE APPLICATION:** Above 4,500 ft Reduce Total System Length by 20 ft [Total System = Air Duct + Tube + Vent]. Refer to manual for model details and orifice chart.

**ORDERING TUBE HEATERS:**

**Order by Complete System: Order Kit Model # on previous page ... or**

**Order by Burner and/or Tube Kits: Part #'s listed below are ordered individually**

**Burner Kits: IWP2 2-Stage Series - Order individually**

All burner assemblies operate on line voltage [120VAC], but are factory ready for 24Vac Thermostat control

BURNER KIT INCLUDES: POWDER COATED HOUSING, FLEXIBLE GAS CONNECTOR, STATUS INDICATOR LIGHTS, ELECTRICAL CORD & PLUG, MOUNTED IGNITER, BIRDSCREENED 4" DIAMETER AIR INTAKE ADAPTER ON BLOWER.

<u>MODEL</u>	<u>ACTUAL CAPACITY</u>	<u>MOUNTS TO TUBE LENGTHS</u>	<u>FUEL TYPE IN PRODUCTION</u>	<u>FLEX GAS CONNECTOR</u>	<u>PART #</u>	<u>LIST PRICE</u>
<b>80/60</b>	78 / 58,000	20', 30'	N.G.*	1/2" x 24"	JJ-TW08-BN	\$ 2,205.00
<b>110/75</b>	110 / 80,000	30', 40'	N.G.*	1/2" x 24"	JJ-TW11-BN	2,205.00
	108 / 70,000 L.P.**	30', 40'	L.P.**	1/2" x 24"	JJ-TW11-BL	2,205.00
<b>130/90</b>	120 / 85,000	30'	N.G. Only	1/2" x 24"	JJ-TW13-BN	2,205.00
	120 / 85,000	40'	N.G.*	1/2" x 24"	JJ-TW13-BN	2,205.00
<b>155/110</b>	150 / 110,000	40', 50'	N.G.*	3/4" X 36"	JJ-TW15-BN	2,333.00
<b>175/125</b>	162 / 115,000	50', 60'	N.G. Only	3/4" X 36"	JJ-TW17-BN	2,386.00
<b>200/140</b>	195 / 140,000	50', 60'	N.G. Only	3/4" X 36"	JJ-TW20-BN	2,386.00

\* Field conversion kits required for LP fuel are listed on page 61; \*\* Burner can be ordered LP see notes page 61

\*\* Burner can be ordered LP see notes page 61

**Aluminized Steel Tube Kits: IWP2 & IWP Series**

ALL Tubes are Aluminized Steel Swaged, Aluminized Reflectors, End Caps, Hangers, Tube Couplers and Turbulator[s]

**Stand-Alone Tube Kits [do not require any additional Tube Kit]**

		<u>TUBE KIT #</u>	<u>LIST PRICE</u>
<b>20': 45/60/80,000</b>	Aluminized steel: Flanged tube + 1 emissive coated tube: Turbulators 4 ft + 8 ft	TW-1420-JZ	\$ 1,034.00
<b>30': 60/80/110/125,000</b>	Flanged aluminized steel tube + 2 emissive coated aluminized tubes: Turbulators 5 ft + 8 ft [5 ft turbulator removed in field for 60 & 80,000]	TW-1430-JZ	1,362.00
<b>40': 80/110/125/150,000</b>	Flanged Aluminized steel tube + 3 emissive coated aluminized tubes Turbulators 2 ft + 10 ft	TW-1040-JZ	1,738.00

**Primary Tube Kits [require a Secondary Kit to make 50', 60' & 70' heaters]**

<b>30': 110/125/150,000</b>	Aluminized steel: Flanged tube + 2 emissive coated tubes: No Turbulator	TW-F030-JZ	1,323.00
<b>30': 175/200,000</b>	Flanged stainless tube + 2 emissive coated aluminized tubes: Turbulator 10 ft	TW-1030-JZ	1,552.00

**Secondary Tube Kits [needed for above Primary Kits to make 50', 60' & 70' heaters]**

<b>20'</b>	Two emissive coated aluminized tubes [makes 50' heater with either 30' primary]	TW-0020-JZ	909.00
<b>30'</b>	Three emissive coated aluminized tubes [makes 60' heater with either 30' primary]	TW-0030-JZ	1,251.00
<b>40'</b>	Four emissive coated aluminized tubes [makes 70' heater with 30' primary TW-1030-JZ]	TW-0040-JZ	1,612.00
<b>10'</b>	One emissive coated aluminized tube, reflector, reflector braces, hanger, tube coupler <b>Do not use the 10 ft tube kit to extend heater length beyond the maximum length approved for any input.</b>	TW-1010-JZ	563.00



Stainless Steel Burner Housing

## Single Stage IW Series

### PATIO, OUTDOOR, & WASH BAY

- Stainless Steel Weather Tight Burner Cabinet
- Aluminized Steel Tubes & Reflectors

**IW SERIES FEATURES:**

- 24V or Line Voltage Thermostat Ready
- Status Indicator Lights
- Power Cord with Plug
- Birdscreened 4" Combustion Air Collar and Intake Wall Hood
- Whisper Quiet Ceramic Burner
- 'Focus Shield' Reflector & End Caps for Premier IR Heat Output
- Emissive Coated Radiant Tubes
- Flexible Gas Connector included
- Factory Mounted Igniter

**COMPLETE TUBE HEATER SYSTEMS:**

OPTIONAL ACCESSORIES PAGES 48 & 49

SYSTEM KIT MODEL #	CAPACITY INPUT [Btuh]	TUBE LENGTH	FUEL	SYSTEM COMPONENT KITS [individual cartons]			LIST PRICE
				Burner Kit #	Tube Kit 1 #	Tube Kit 2 #	
PU-W040-AN	40,000	10'U	NG*	[U-Tube; Factory Assembled in Carton - details Page 15]			\$ 3,456.00
IW-45-20-AN	45,000	20'	NG*	JJ-P045-BN	TW-1420-JZ	-	3,446.00
IW-60-20-AN	60,000	20'	NG*	JJ-P060-BN	TW-1420-JZ	-	3,446.00
IW-60-30-AN		30'		JJ-P060-BN	TW-1430-JZ	-	3,772.00
IW-80-20-AN	80,000	20'	NG*	JJ-P080-BN	TW-1420-JZ	-	3,446.00
IW-80-30-AN		30'		JJ-P080-BN	TW-1430-JZ	-	3,772.00
IW-80-40-AN		40'		JJ-P080-BN	TW-1040-JZ	-	4,150.00
IW-110-30-AN	110,000	30'	NG*	JJ-P110-BN	TW-1430-JZ	-	3,772.00
IW-110-30-AL	110,000	30'	LP**	JJ-P110-BL	TW-1430-JZ	-	3,772.00
IW-110-40-AN		40'	NG*	JJ-P110-BN	TW-1040-JZ	-	4,150.00
IW-110-40-AL		40'	LP**	JJ-P110-BL	TW-1040-JZ	-	4,150.00
IW-110-50-AN		50'	NG*	JJ-P110-BN	TW-F030-JZ	TW-0020-JZ	4,645.00
IW-110-50-AL		50'	LP**	JJ-P110-BL	TW-F030-JZ	TW-0020-JZ	4,645.00
IW-130-30-AN	125,000	30'	NG Only	JJ-P130-BN	TW-1430-JZ	-	3,772.00
IW-130-40-AN		40'	NG*	JJ-P130-BN	TW-1040-JZ	-	4,150.00
IW-130-50-AN		50'	NG*	JJ-P130-BN	TW-F030-JZ	TW-0020-JZ	4,645.00
IW-155-40-AN	150,000	40'	NG*	JJ-P155-BN	TW-1040-JZ	-	4,242.00
IW-155-50-AN		50'		JJ-P155-BN	TW-F030-JZ	TW-0020-JZ	4,735.00
IW-155-60-AN		60'		JJ-P155-BN	TW-F030-JZ	TW-0030-JZ	5,076.00
IW-175-50-AL	175,000	50'	LP**	JJ-P175-BL	TW-1030-JZ	TW-0020-JZ	5,052.00
IW-175-50-AN		50'	NG*	JJ-P175-BN	TW-1030-JZ	TW-0020-JZ	5,052.00
IW-175-60-AL		60'	LP**	JJ-P175-BL	TW-1030-JZ	TW-0030-JZ	5,393.00
IW-175-60-AN		60'	NG*	JJ-P175-BN	TW-1030-JZ	TW-0030-JZ	5,393.00
IW-175-70-AN		70'	NG Only	JJ-P175-BN	TW-1030-JZ	TW-0040-JZ	5,754.00
IW-200-50-AN	200,000	50'	NG Only	JJ-P200-BN	TW-1030-JZ	TW-0020-JZ	5,052.00
IW-200-60-AL		60'	LP**	JJ-P200-BL	TW-1030-JZ	TW-0030-JZ	5,393.00
IW-200-60-AN		60'	NG*	JJ-P200-BN	TW-1030-JZ	TW-0030-JZ	5,393.00
IW-200-70-AL		70'	LP**	JJ-P200-BL	TW-1030-JZ	TW-0040-JZ	5,754.00
IW-200-70-AN		70'	NG*	JJ-P200-BN	TW-1030-JZ	TW-0040-JZ	5,754.00

\* Field conversion kits required for LP fuel are listed on page 61; \*\* Burner can be ordered LP see notes page 61

A Tube Heater System ships in 2 or 3 individual cartons with a Burner Kit + Tube Kit[s] required for heater length Burner Kits, and tube kits are packaged separately and clearly labelled for ease of assembling orders and shipment

**HIGH ALTITUDE APPLICATION:** Above 4,500 ft Reduce Total System Length by 20 ft [Total System = Air Duct + Tube + Vent]. Refer to manual for model details and orifice chart.

**ORDERING TUBE HEATERS:**

**Order by Complete System: Order Kit Model # on previous page ... or**

**Order by Burner and/or Tube Kits: Part #'s listed below can be ordered individually**

**Burner Kits: IW Series - Stainless Steel Housing**

- Can be ordered individually

All burner assemblies operate on line voltage [120VAC], but are factory ready for 24Vac Thermostat control

BURNER KIT INCLUDES: FLEXIBLE GAS CONNECTOR, STATUS INDICATOR LIGHTS, ELECTRICAL CORD & PLUG, MOUNTED IGNITER, BIRDSCREENED 4" DIAMETER AIR INTAKE ADAPTER ON BLOWER.

<u>CAPACITY</u>	<u>MOUNTS TO TUBE LENGTHS</u>	<u>FUEL TYPE IN PRODUCTION</u>	<u>FLEX GAS CONNECTOR</u>	<u>PART #</u>	<u>LIST PRICE</u>
45,000 Btuh	20'	N.G.*	1/2" x 24"	JJ-P045-BN	\$ 2,413.00
60,000 Btuh	20', 30'	N.G.*	1/2" x 24"	JJ-P060-BN	2,413.00
80,000 Btuh	20', 30', 40'	N.G.*	1/2" x 24"	JJ-P080-BN	2,413.00
110,000 Btuh	30', 40', 50'	N.G.*	1/2" x 24"	JJ-P110-BN	2,413.00
110,000 Btuh LP **	30', 40', 50'	LP**	1/2" x 24"	JJ-P110-BL	2,413.00
125,000 Btuh	30'	N.G. Only	1/2" x 24"	JJ-P130-BN	2,413.00
125,000 Btuh	40', 50'	N.G.*	1/2" x 24"	JJ-P130-BN	2,413.00
150,000 Btuh	40', 50', 60'	N.G.*	3/4" X 36"	JJ-P155-BN	2,503.00
175,000 Btuh	50', 60', 70'	N.G.* [70' is NG Only]	3/4" X 36"	JJ-P175-BN	2,592.00
175,000 Btuh LP **	50', 60'	LP**	3/4" X 36"	JJ-P175-BL	2,592.00
200,000 Btuh	50', 60', 70'	N.G.*	3/4" X 36"	JJ-P200-BN	2,592.00
200,000 Btuh LP **	60', 70'	LP**	3/4" X 36"	JJ-P200-BL	2,592.00

\* Field conversion kits required for LP fuel are listed on page 61; \*\* Burner can be ordered LP see notes page 61

**Aluminized Steel Tube Kits: IW Series**

- Can be ordered individually

ALL Tubes are Aluminized Steel Swaged, Aluminized Reflectors, End Caps, Hangers, Tube Couplers and Turbulator[s]

**Stand-Alone Tube Kits [do not require any additional Tube Kit]**

		<u>TUBE KIT #</u>	<u>LIST PRICE</u>
<b>20': 45/60/80,000</b>	Aluminized steel: Flanged tube + 1 emissive coated tube: Turbulators 4 ft + 8 ft	TW-1420-JZ	\$ 1,034.00
<b>30': 60/80/110/125,000</b>	Flanged aluminized steel tube + 2 emissive coated aluminized tubes: Turbulators 5 ft + 8 ft [5 ft turbulator removed in field for 60 & 80,000]	TW-1430-JZ	1,362.00
<b>40': 80/110/125/150,000</b>	Flanged Aluminized steel tube + 3 emissive coated aluminized tubes Turbulators 2 ft + 10 ft	TW-1040-JZ	1,738.00

**Primary Tube Kits [require a Secondary Kit to make 50', 60' & 70' heaters]**

<b>30': 110/125/150,000</b>	Aluminized steel: Flanged tube + 2 emissive coated tubes: Turbulator 2 ft	TW-F030-JZ	1,323.00
<b>30': 175/200,000</b>	Flanged stainless tube + 1 aluminized steel tube + 1 emissive coated aluminized tube: Turbulator 10 ft	TW-1030-JZ	1,552.00

**Secondary Tube Kits [needed with above Primary Kits to make 50', 60' & 70' heaters]**

<b>20'</b>	Two emissive coated aluminized tubes [makes 50' heater with either 30' primary]	TW-0020-JZ	909.00
<b>30'</b>	Three emissive coated aluminized tubes [makes 60' heater with either 30' primary]	TW-0030-JZ	1,251.00
<b>40'</b>	Four emissive coated aluminized tubes [makes 70' heater with 30' primary TW-1030-JZ]	TW-0040-JZ	1,612.00
<b>10'</b>	One emissive coated aluminized tube, reflector, reflector braces, hanger, tube coupler Do not use the 10 ft tube kit to extend heater length beyond the maximum length approved for any input.	TW-1010-JZ	563.00

## Two-Stage IW2 Series

### PATIO, OUTDOOR, & WASH BAY

- Stainless Steel Water Tight Burner Housing
- Aluminized Steel Reflectors & Tubes

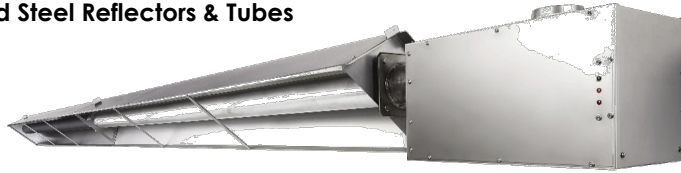

#### STW-JZ FEATURES:

- 24V or Line Voltage Thermostat Ready
- Status Indicator Lights
- Power Cord with Plug
- Birdscreened 4" Combustion Air Collar and Intake Wall Hood
- 'Focus Shield' Reflector & End Caps for Premier IR Heat Output
- Emissive Coated Radiant Tubes
- Flexible Gas Connector included

#### COMPLETE TUBE HEATER SYSTEMS:

OPTIONAL ACCESSORIES PAGES 48 & 49

SYSTEM KIT MODEL #	CAPACITY INPUT [Btuh]	TUBE		SYSTEM COMPONENT KITS [individual cartons]			LIST PRICE
		LENGTH	FUEL	Burner Kit #	Tube Kit 1 #	Tube Kit 2 #	
IW2-80-20-AN	78/58,000	20'	NG*	JJ-TP08-BN	TW-1420-JZ	-	\$ 3,611.00
IW2-80-30-AN		30'	NG*	JJ-TP08-BN	TW-1430-JZ	-	3,939.00
IW2-110-30-AN	110/80,000	30'	NG*	JJ-TP11-BN	TW-1430-JZ	-	3,939.00
IW2-110-30-AL	108/70,000	30'	LP**	JJ-TP11-BL	TW-1430-JZ	-	3,939.00
IW2-110-40-AN		40'	NG*	JJ-TP11-BN	TW-1040-JZ	-	4,314.00
IW2-110-40-AL		40'	LP**	JJ-TP11-BL	TW-1040-JZ	-	4,314.00
IW2-130-30-AN	120/85,000	30'	NG Only	JJ-TP13-BN	TW-1430-JZ	-	3,939.00
IW2-130-40-AN		40'	NG*	JJ-TP13-BN	TW-1040-JZ	-	4,314.00
IW2-155-40-AN	150/110,000	40'	NG*	JJ-TP15-BN	TW-1040-JZ	-	4,425.00
IW2-155-50-AN		50'	NG*	JJ-TP15-BN	TW-F030-JZ	TW-0020-JZ	4,920.00
<b>175 &amp; 200 Models not suitable for Patio application</b>							
IW2-175-50-AN	162/115,000	50'	NG Only	JJ-TP17-BN	TW-1030-JZ	TW-0020-JZ	\$ 5,221.00
IW2-175-60-AN		60'	NG Only	JJ-TP17-BN	TW-1030-JZ	TW-0030-JZ	5,565.00
IW2-200-50-AN	195/140,000	50'	NG Only	JJ-TP20-BN	TW-1030-JZ	TW-0020-JZ	5,221.00
IW2-200-60-AN		60'	NG Only	JJ-TP20-BN	TW-1030-JZ	TW-0030-JZ	5,565.00

\* Field conversion kits required for LP fuel are listed on page 61; \*\* Burner can be ordered LP see notes page 61

A Tube Heater System ships in 2 or 3 individual cartons with a Burner Kit + Tube Kit[s] required for heater length  
Burner Kits, and tube kits are packaged separately and clearly labelled for ease of assembling orders and shipment

**HIGH ALTITUDE APPLICATION:** Above 4,500 ft Reduce Total System Length by 20 ft [Total System = Air Duct + Tube + Vent].  
Refer to manual for model details and orifice chart.

**ORDERING TUBE HEATERS:**

Order by Complete System: Order Kit Model # on previous page ... or

Order by Burner and/or Tube Kits: Part #'s listed below are ordered individually

**Burner Kits: IW2 2-Stage Series - Order individually**

All burner assemblies operate on line voltage [120VAC], but are factory ready for 24Vac Thermostat control

BURNER KIT INCLUDES: STAINLESS STEEL HOUSING, FLEXIBLE GAS CONNECTOR, STATUS INDICATOR LIGHTS, ELECTRICAL CORD & PLUG, MOUNTED IGNITER, BIRDSCREENED 4" DIAMETER AIR INTAKE ADAPTER ON BLOWER.

<u>MODEL</u>	<u>ACTUAL CAPACITY</u>	<u>MOUNTS TO TUBE LENGTHS</u>	<u>FUEL TYPE IN PRODUCTION</u>	<u>FLEX GAS CONNECTOR</u>	<u>PART #</u>		<u>LIST PRICE</u>
<b>80/60</b>	78 / 58,000	20', 30'	N.G.*	1/2" x 24"	JJ-TP08-BN	\$	2,577.00
<b>110/75</b>	110 / 80,000	30', 40'	N.G.*	1/2" x 24"	JJ-TP11-BN		2,577.00
	108 / 70,000 L.P.**	30', 40'	L.P.**	1/2" x 24"	JJ-TP11-BL		2,577.00
<b>130/90</b>	120 / 85,000	30'	N.G. Only	1/2" x 24"	JJ-TP13-BN		2,577.00
	120 / 85,000	40'	N.G.*	1/2" x 24"	JJ-TP13-BN		2,577.00
<b>155/110</b>	150 / 110,000	40', 50'	N.G.*	3/4" X 36"	JJ-TP15-BN		2,687.00
<b>175/125</b>	162 / 115,000	50', 60'	N.G. Only	3/4" X 36"	JJ-TP17-BN		2,763.00
<b>200/140</b>	195 / 140,000	50', 60'	N.G. Only	3/4" X 36"	JJ-TP20-BN		2,763.00

\* Field conversion kits required for LP fuel are listed on page 61; \*\* Burner can be ordered LP see notes page 61

\*\* Burner can be ordered LP see notes page 61

**Aluminized Steel Tube Kits: IW2 & IW Series**

ALL Tubes are Aluminized Steel Swaged, Aluminized Reflectors, End Caps, Hangers, Tube Couplers and Turbulator[s]

**Stand-Alone Tube Kits [do not require any additional Tube Kit]**

		<u>TUBE KIT #</u>		<u>LIST PRICE</u>
<b>20': 45/60/80,000</b>	Aluminized steel: Flanged tube + 1 emissive coated tube: Turbulators 4 ft + 8 ft	TW-1420-JZ	\$	1,034.00
<b>30': 60/80/110/125,000</b>	Flanged aluminized steel tube + 2 emissive coated aluminized tubes: Turbulators 5 ft + 8 ft [5 ft turbulator removed in field for 60 & 80,000]	TW-1430-JZ		1,362.00
<b>40': 80/110/125/150,000</b>	Flanged Aluminized steel tube + 3 emissive coated aluminized tubes Turbulators 2 ft + 10 ft	TW-1040-JZ		1,738.00

**Primary Tube Kits [require a Secondary Kit to make 50', 60' & 70' heaters]**

<b>30': 110/125/150,000</b>	Aluminized steel: Flanged tube + 2 emissive coated tubes: No Turbulator	TW-F030-JZ		1,323.00
<b>30': 175/200,000</b>	Flanged stainless tube + 2 emissive coated aluminized tubes: Turbulator 10 ft	TW-1030-JZ		1,552.00

**Secondary Tube Kits [needed for above Primary Kits to make 50', 60' & 70' heaters]**

<b>20'</b>	Two emissive coated aluminized tubes [makes 50' heater with either 30' primary]	TW-0020-JZ		909.00
<b>30'</b>	Three emissive coated aluminized tubes [makes 60' heater with either 30' primary]	TW-0030-JZ		1,251.00
<b>40'</b>	Four emissive coated aluminized tubes [makes 70' heater with 30' primary TW-1030-JZ]	TW-0040-JZ		1,612.00
<b>10'</b>	One emissive coated aluminized tube, reflector, reflector braces, hanger, tube coupler <b>Do not use the 10 ft tube kit to extend heater length beyond the maximum length approved for any input.</b>	TW-1010-JZ		563.00



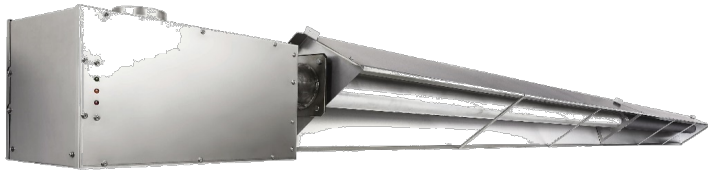

**IW2 FEATURES:**

- Stainless Steel Burner Housing
- 24V or Line Voltage Thermostat Ready
- Status Indicator Lights
- Power Cord with Plug
- Birdscreened 4" Combustion Air Collar and Intake Wall Hood
- Whisper Quiet Ceramic Burner
- 'Focus Shield' Reflector & End Caps for Premier IR Heat Output
- Emissive Coated Radiant Tubes
- Flexible Gas Connector included
- Factory Mounted Igniter

## Single Stage IWS Series

**HARSH ENVIRONMENT, PATIO\*, OUTDOOR, & WASH BAYS**

- Stainless Steel Water Tight Burner Cabinet
- Stainless Steel Tubes & Reflectors

**COMPLETE TUBE HEATER SYSTEMS:**

OPTIONAL ACCESSORIES PAGES 48 & 49

SYSTEM KIT MODEL #	CAPACITY INPUT [Btuh]	TUBE LENGTH	FUEL	SYSTEM COMPONENT KITS [individual cartons]			LIST PRICE
				Burner Kit #	Tube Kit 1 #	Tube Kit 2 #	
IWS-45-20-AN	45,000	20'	NG*	JJ-P045-BN	TW-1420-JZ-2	-	\$ 4,670.00
IWS-60-30-AN	60,000	30'	NG*	JJ-P060-BN	TW-1430-JZ-2	-	5,565.00
IWS-80-30-AN	80,000	30'	NG*	JJ-P080-BN	TW-1430-JZ-2	-	5,565.00
IWS-80-40-AN		40'		JJ-P080-BN	TW-1040-JZ-2	-	6,461.00
IWS-110-40-AN	110,000	40'	NG*	JJ-P110-BN	TW-1040-JZ-2	-	6,461.00
IWS-110-40-AL		40'	LP**	JJ-P110-BL	TW-1040-JZ-2	-	6,461.00
IWS-110-50-AN		50'	NG*	JJ-P110-BN	TW-F030-JZ-2	TW-0020-JZ-2	7,639.00
IWS-110-50-AL		50'	LP**	JJ-P110-BL	TW-F030-JZ-2	TW-0020-JZ-2	7,639.00
IWS-130-40-AN	125,000	40'	NG*	JJ-P130-BN	TW-1040-JZ-2	-	6,461.00
IWS-130-50-AN		50'		JJ-P130-BN	TW-F030-JZ-2	TW-0020-JZ-2	7,639.00
IWS-155-50-AN	150,000	50'	NG*	JJ-P155-BN	TW-F030-JZ-2	TW-0020-JZ-2	7,726.00
IWS-155-60-AN		60'		JJ-P155-BN	TW-F030-JZ-2	TW-0030-JZ-2	8,623.00
IWS-175-60-AL	175,000	60'	LP**	JJ-P175-BL	TW-1030-JZ-2	TW-0030-JZ-2	8,707.00
IWS-175-60-AN		60'	NG*	JJ-P175-BN	TW-1030-JZ-2	TW-0030-JZ-2	8,707.00
IWS-175-70-AN		70'	NG* Only	JJ-P175-BN	TW-1030-JZ-2	TW-0040-JZ-2	9,603.00
IWS-200-60-AL	200,000	60'	LP**	JJ-P200-BL	TW-1030-JZ-2	TW-0030-JZ-2	8,707.00
IWS-200-60-AN		60'	NG*	JJ-P200-BN	TW-1030-JZ-2	TW-0030-JZ-2	8,707.00
IWS-200-70-AL		70'	LP**	JJ-P200-BL	TW-1030-JZ-2	TW-0040-JZ-2	9,603.00
IWS-200-70-AN		70'	NG*	JJ-P200-BN	TW-1030-JZ-2	TW-0040-JZ-2	9,603.00

\* Field conversion kits required for LP fuel are listed on page 61; \*\* Burner can be ordered LP see notes page 61

A Tube Heater System ships in 2 or 3 individual cartons with a Burner Kit + Tube Kit[s] required for heater length Burner Kits, and tube kits are packaged separately and clearly labelled for ease of assembling orders and shipment

**HIGH ALTITUDE APPLICATION:** Above 4,500 ft Reduce Total System Length by 20 ft [Total System = Air Duct + Tube + Vent]. Refer to manual for model details and orifice chart.



**ORDERING TUBE HEATERS:**

- n Order by Complete System: Order Kit Model # on previous page ... or
- n Order by Burner and/or Tube Kits: Part #'s listed below can be ordered individually

**Burner Kits: IW Burner Kits - Stainless Steel Housing for IWS Series Systems**

- Can be ordered individually

All burner assemblies operate on line voltage [120VAC], but are factory ready for 24Vac Thermostat control

BURNER KIT INCLUDES: FLEXIBLE GAS CONNECTOR, STATUS INDICATOR LIGHTS, ELECTRICAL CORD & PLUG, MOUNTED IGNITER, BIRDSCREENED 4" DIAMETER AIR INTAKE ADAPTER ON BLOWER.

<u>CAPACITY</u>	<u>MOUNTS TO TUBE LENGTHS</u>	<u>FUEL TYPE IN PRODUCTION</u>	<u>FLEX GAS CONNECTOR</u>	<u>PART #</u>	<u>LIST PRICE</u>
45,000 Btuh	20'	N.G.*	1/2" x 24"	JJ-P045-BN	\$ 2,413.00
60,000 Btuh	30'	N.G.*	1/2" x 24"	JJ-P060-BN	2,413.00
80,000 Btuh	30', 40'	N.G.*	1/2" x 24"	JJ-P080-BN	2,413.00
110,000 Btuh	40', 50'	N.G.*	1/2" x 24"	JJ-P110-BN	2,413.00
110,000 Btuh LP **	40', 50'	LP.**	1/2" x 24"	JJ-P110-BL	2,413.00
125,000 Btuh	40', 50'	N.G.*	1/2" x 24"	JJ-P130-BN	2,413.00
150,000 Btuh	50', 60'	N.G.*	3/4" X 36"	JJ-P155-BN	2,503.00
175,000 Btuh	60', 70'	N.G.* [70' is NG Only]	3/4" X 36"	JJ-P175-BN	2,592.00
175,000 Btuh LP **	60'	LP.**	3/4" X 36"	JJ-P175-BL	2,592.00
200,000 Btuh	60', 70'	N.G.*	3/4" X 36"	JJ-P200-BN	2,592.00
200,000 Btuh LP **	60', 70'	LP.**	3/4" X 36"	JJ-P200-BL	2,592.00

\* Field conversion kits required for LP fuel are listed on page 61; \*\* Burner can be ordered LP see notes page 61

**Stainless Steel Tube Kits: for IWS Series Systems**

- Can be ordered individually

Include Stainless Swaged Tubes, Stainless Reflectors, End Caps, Hangers, Tube Couplers and Turbulator[s] as required

**Stand-Alone Tube Kits [do not require any additional Tube Kit]**

		<u>TUBE KIT #</u>	<u>LIST PRICE</u>
20': 45,000	Stainless steel Flanged tube + 1 stainless steel tube: Turbulators 4 ft + 8 ft	TW-1420-JZ-2	\$ 2,374.00
30': 60,000/80,000	Stainless steel Flanged tube + 2 stainless steel tubes: Turbulator 8 ft	TW-1430-JZ-2	3,272.00
40': 80/110/125,000	Stainless steel Flanged tube + 3 stainless steel tubes: Turbulators 2 ft + 10 ft	TW-1040-JZ-2	4,164.00

**Primary Tube Kits [require a Secondary Kit to make 50', 60' & 70' heaters]**

30': 110/125/150,000	Stainless steel Flanged tube + 2 stainless steel tubes: No Turbulator	TW-F030-JZ-2	3,272.00
30': 175/200,000	Stainless steel Flanged tube + 2 stainless steel tubes: Turbulator 10 ft	TW-1030-JZ-2	3,272.00

**Secondary Tube Kits [needed with above Primary Kits to make 50', 60' & 70' heaters]**

20'	Two stainless steel tubes [makes 50' heater with TW-F030-JZ-2 primary] 50 ft systems for inputs 110,000, 125,000, & 150,000 only	TW-0020-JZ-2	2,075.00
30'	Three stainless steel tubes [makes 60' heater with either 30' primary]	TW-0030-JZ-2	2,970.00
40'	Four stainless steel tubes [makes 70' heater with 30' primary TW-1030-JZ]	TW-0040-JZ-2	3,866.00
10'	One stainless steel tube, reflector, reflector braces, hanger, tube coupler Do not use the 10 ft tube kit to extend heater length beyond the maximum length approved for any input.	TW-1010-JZ-2	1,180.00

## Two Stage IW2S Series

### PATIO, OUTDOOR, & WASH BAYS

- Stainless Steel Water Tight Burner Cabinet
- ALL Stainless Steel Tube & Reflector System



#### IWS2 FEATURES:

- All stainless steel construction
- 24V or Line Voltage Thermostat Ready
- Status Indicator Lights
- Power Cord with Plug
- Birdscreened 4" Combustion Air Collar and Intake Wall Hood
- 'Focus Shield' Reflector & End Caps for Premier IR Heat Output
- Flexible Gas Connector included

#### COMPLETE TUBE HEATER SYSTEMS:

OPTIONAL ACCESSORIES PAGES 48 & 49

SYSTEM KIT MODEL #	CAPACITY INPUT [Btuh]	TUBE		SYSTEM COMPONENT KITS [individual cartons]			LIST PRICE
		LENGTH	FUEL	Burner Kit #	Tube Kit 1 #	Tube Kit 2 #	
IW2S-80-30-AN	78/58,000	30'	NG*	JJ-TP08-BN	TW-1430-JZ-2	-	\$ 5,849.00
IW2S-110-40-AN	110/80,000	40'	NG*	JJ-TP11-BN	TW-1040-JZ-2	-	6,741.00
IW2S-110-40-AL	108/70,000	40'	LP**	JJ-TP11-BL	TW-1040-JZ-2	-	6,741.00
IW2S-130-40-AN	120/85,000	40'	NG*	JJ-TP13-BN	TW-1040-JZ-2	-	6,741.00
IW2S-155-50-AN	150/110,000	50'	NG*	JJ-TP15-BN	TW-F030-JZ-2	TW-0020-JZ-2	8,034.00
<b>175 &amp; 200 Models not suitable for Patio application</b>							
IW2S-175-60-AN	162/115,000	60'	NG Only	JJ-TP17-BN	TW-1030-JZ-2	TW-0030-JZ-2	9,005.00
IW2S-200-60-AN	195/140,000	60'	NG Only	JJ-TP20-BN	TW-1030-JZ-2	TW-0030-JZ-2	9,005.00

\* Field conversion kits required for LP fuel are listed on page 61; \*\* Burner can be ordered LP see notes page 61

A Tube Heater System ships in 2 or 3 individual cartons with a Burner Kit + Tube Kit[s] required for heater length  
Burner Kits, and tube kits are packaged separately and clearly labelled for ease of assembling orders and shipment

**ORDERING TUBE HEATERS:**

Order by Complete System Kit Numbers: Order Kit Model # on previous page ... or

Order by Burner and/or Tube Kits: Part #'s listed below are ordered individually

**Burner Kits: IW2 2-Stage Burner Kits for IW2S Series Systems**

All burner assemblies operate on line voltage [120VAC], but are factory ready for 24Vac Thermostat control

BURNER KIT INCLUDES: STAINLESS STEEL HOUSING, FLEXIBLE GAS CONNECTOR, STATUS INDICATOR LIGHTS, ELECTRICAL CORD & PLUG, MOUNTED IGNITER, BIRDSCREENED 4" DIAMETER AIR INTAKE ADAPTER ON BLOWER.

<u>MODEL</u>	<u>ACTUAL CAPACITY</u>	<u>MOUNTS TO TUBE LENGTHS</u>	<u>FUEL TYPE IN PRODUCTION</u>	<u>FLEX GAS CONNECTOR</u>	<u>PART #</u>		<u>LIST PRICE</u>
80/60	78 / 58,000	30'	N.G.*	1/2" x 24"	JJ-TP08-BN	\$	2,577.00
110/75	110 / 80,000	40'	N.G.*	1/2" x 24"	JJ-TP11-BN		2,577.00
110/75	108 / 70,000 L.P.**	40'	L.P.**	1/2" x 24"	JJ-TP11-BL		2,577.00
130/90	120 / 85,000	40'	N.G.*	1/2" x 24"	JJ-TP13-BN		2,577.00
155/110	150 / 110,000	50'	N.G.*	3/4" X 36"	JJ-TP15-BN		2,687.00
175/125	162 / 115,000	60'	N.G. Only	3/4" X 36"	JJ-TP17-BN		2,763.00
200/140	195 / 140,000	60'	N.G. Only	3/4" X 36"	JJ-TP20-BN		2,763.00

\* Field conversion kits required for LP fuel are listed on page 61; \*\* Burner can be ordered LP see notes page 61

\*\* Burner can be ordered LP see notes page 61

**Stainless Steel Tube Kits: For IW2S Series Systems**

- Ordered individually

Includes Stainless Swaged Tubes, Stainless Reflectors, End Caps, Hangers, Tube Couplers and Turbulator[s] as required

**Stand-Alone Tube Kits [do not require any additional Tube Kit]**

		<u>TUBE KIT #</u>	<u>LIST PRICE</u>
30': 80/60	Stainless steel Flanged tube + 2 stainless steel tubes: Turbulator 8 ft	TW-1430-JZ-2	3,272.00
40': 110/75, 130/90	Stainless steel Flanged tube + 3 stainless steel tubes: Turbulators 2 ft + 10 ft	TW-1040-JZ-2	4,164.00

**Primary Tube Kits [require a Secondary Kit to make 50', 60' & 70' heaters]**

30': 155/110	Stainless steel Flanged tube + 2 stainless steel tubes: No Turbulator	TW-F030-JZ-2	3,272.00
30': 175/125, 200/140	Stainless steel Flanged tube + 2 stainless steel tubes: Turbulator 10 ft	TW-1030-JZ-2	3,272.00

**Secondary Tube Kits [needed with above Primary Kits to make 50' & 60' heaters]**

20'	Two stainless steel tubes [makes 50' heater with TW-F030-JZ-2 Primary Kit] 50 ft systems for inputs 110,000, 125,000, & 150,000 only	TW-0020-JZ-2	2,075.00
30'	Three stainless steel tubes [makes 60' heater with either 30' Primary Kit]	TW-0030-JZ-2	2,970.00
10'	One stainless steel tube, reflector, reflector braces, hanger, tube coupler	TW-1010-JZ-2	1,180.00

**Do not use the 10 ft tube kit to extend heater length beyond the maximum length approved for any input.**

## OPTIONAL ACCESSORIES - Page 1 of 2 IWP, IW & IW2 TUBE HEATERS

### Wet Environment & Outdoor Temperature Control:

NEMA 4X Rated Thermostat



PART #	LIST PRICE
JS-0570-XX	\$ 162.00

NOTE: Heater Suspension items are not available from Infrasave in stainless steel

### Hanging Chain:

#2 Lion Chain - 115 lb work load - 200 ft roll



PART #	LIST PRICE
JL-0800-XX	\$ 175.00

Quantity of Chain required:  $IW, IWP \text{ Series heater} = \left[ \left( \frac{\text{heater tube length}}{10} \right) + 2 \right] \times \text{length of chain at each suspension point}$   
 ie: IWP 40 ft heater 3 ft below structural support =  $\left[ \left( \frac{40}{10} \right) + 2 \right] \times 3 = 18 \text{ ft of chain}$

### Safety Snap Hooks - 2"



Package of 24	JL-0800-SH	72.00
Package of 100	JL-0800-SH-B	220.00

'S' Hooks - 1 7/8" - Package of 25

JL-0798-SH	41.00
------------	-------

Quantity of 'Snap' or 'S' Hooks:  $IW, IWP \text{ Series quantity required} = \left[ \left( \frac{\text{tube length}}{10} \right) \times 2 \right] + 4$  : ie: SPW-JZ x 40 ft =  $\left[ \left( \frac{40}{10} \right) \times 2 \right] + 4 = 12 \text{ hooks}$

### CLEARANCE TO COMBUSTIBLES SIGN

Metal sign - 18" x 6"  
- 3/4" red lettering on white background

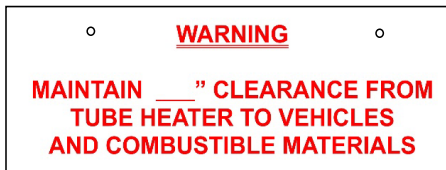

JL-0798-CS	67.00
------------	-------

### Vent Options:



Horizontal / Wall Terminal\*

#### Flue Vent Terminals:

Flue Vent Terminals:	PART #	LIST PRICE
4" horizontal [through wall]	JA-0528-XX	\$ 47.00
6" horizontal	JA-0529-XX	57.00

Vent Tee 4" X 4" X 6" - **Not Available in Stainless Steel**  
[Two Couplers JA-0516-AA are optional]

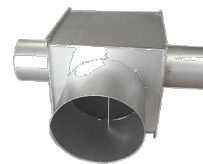

JA-0514-XX	234.00
------------	--------

Optional Couplers for Vent Tee:

4" x 8" Aluminized Steel Coupler with 2 x U-Bolts  
[ADD TWO optional tube couplers JA-0516-AA or JA-0516-XX if desired for vent pipe connection to Tee]

JA-0516-AA	78.00
------------	-------

HORIZONTAL VENTING: Use the 'Wall' termination cap by Infrasave, or use an approved 'High Wind' termination cap

VERTICAL VENTING: Use the termination cap for double walled pipe as supplied by the vent pipe manufacturer

\* Fits single wall vent pipe - field modification required to fit to double wall pipe

## OPTIONAL ACCESSORIES - Page 2 of 2

### IWP, IW & IW2 TUBE HEATERS

#### Modular Elbow Kit:

**Note: Stainless Steel accessories have longer lead times**

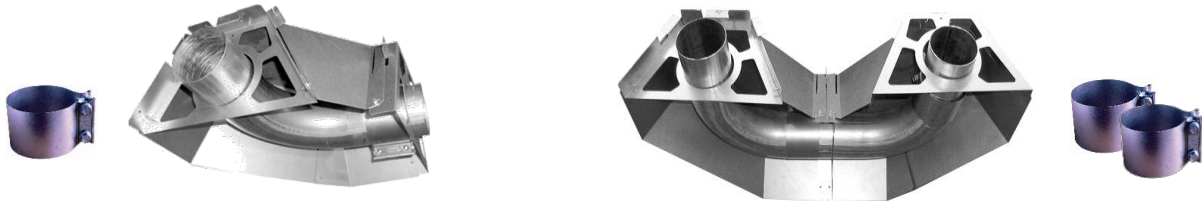

<b>IW &amp; IWP 90°</b> Aluminumized Steel Elbow & Reflector Cover Kit: [Elbow can be installed right or left hand - Includes Coupler, Reflector Cover, Hanger Plate]	JS-0508-JZ	\$	284.00
<b>IW &amp; IWP 180°</b> Elbow & Reflector Cover Kit: ORDER: TWO x 90° ELBOW KITS	Qty 2 x JS-0508-JZ		568.00
<b>IW2: 90° Stainless Steel Elbow &amp; Reflector Cover Kit: [Longer lead time]</b> For 180° Elbow Kits = Combine TWO JS-0508-JZ[-2] Kits as Required	JS-0508-JZ-2		525.00

**Ü Reflector Angle Adapter** - ONE REQUIRED AT EACH JUNCTURE of an angle change JS-0504-JZ 30.00

**NOTE:** The elbow reflector cap must always be in the horizontal plane - cap cannot be angle mounted  
The Reflector Angle Adapter is required for angle mounting a reflector section before or after an elbow  
Or for mounting of a reflector section at a different angle relative to the other reflectors in the system.

#### Other Optional Accessories:

##### Decorative 'Tuxedo' Grille Kit - Matte Black Finish

Dress up your tube heater installations.

- Ideal for: Patios
- Retail areas
- Showrooms



Matte black aluminum grille & aluminumized steel framing secures with tabs to 'JZ' Series reflectors.

Decorative 'Tuxedo' Grille Kit - 10 ft - Matte Black Grille	Each 10 foot section	TG-0010-KT	\$	638.00
---	----------------------	------------	----	--------

##### Reflector Side Extension Extension

- IW & IWP models - 10" deep x 116" long c/w Qty 3 x 'S' hooks	JS-0509-KT			86.00
--	------------	--	--	-------

##### Tube Protection Screen '-JZ' Tube Kit - 5 ft length

- [1/2" x 1/2" galvanized screen]
- [custom order: longer lead time]
- [not available stainless steel]

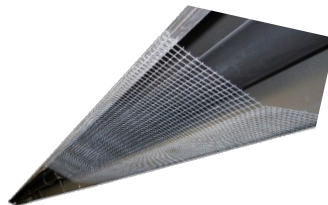

JA-0780-XX				157.00
------------	--	--	--	--------

## PATIO HEATER SELECTION GUIDELINES

Patio layouts and conditions differ widely and usually require a unique heating solution for each patio. Below are some guidelines to assist in the selection of heaters for your patio project. Infrasave offers design services for patio projects. Copy, complete and submit the form at the back of this price list.

### General

- ⚡ Gas fired infrared radiant heat is ideal for "spot comfort" applications like patios, waiting lines, and smoking areas.
- ⚡ Besides temperature, wind-chill is the greatest opponent to comfort - any wind break will improve outdoor comfort.
- ⚡ Heating customers from at least two sides is much more effective than heating from only one side
- ⚡ If a project faces budget constraints, it is most effective to heat only a portion of a patio. Spreading too few heaters over a larger area will not satisfy customers nor the owner.
- ⚡ Patio heating supplies customer seating in a welcomed surrounding more cost-effectively than any other renovation
- ⚡ 24 volt control patio heater models can be centrally operated from a patio panel, or by remote control.

	High Intensity		Tube Heaters		Electric
	IO-100-SS	IO-210-SS	IWP	IW	EL/ELD
Open Patio Area	P	P			
Canopy / Roof Over	R	R	P	P	P
Enclosed Area	R	R	P	P	P
Coastal Salt-Air Location	P	P		P	
Perimeter Mount	P	P	P	P	P
Permanent Mount	P	P	P	P	P
Central Panel Control	P	P	P	P	P
Remote Hand Set Control	P	P	P	P	
Natural Gas or Propane	PRR	PRR	P	P	

R High Intensity approved for indoor and covered areas provided there is sufficient exhaust installed:  
 \_ National Fuel Gas Code (NFPA 54) requires 4 cfm for each 1,000 Btuh input  
 RR Two Stage IO-152-SS available NG Only

### IO-100 Series High Intensity Heaters

- Single-stage 35,000 and 50,000 Btuh: Natural Gas or Propane Gas; 2-Stage 50,000/36,500: Natural Gas Only
- 24V electrical supply & ignition - central or remote control; 2-Stage unit require switch gang controls listed on page 50
- Best suited to 'open' patios
- Available with Marine Grade Stainless Steel outer assembly
- Finishes: Black high temperature coated stainless steel [409] outer assembly - improves aesthetic and helps heater "disappear"  
 [316] Marine Grade Stainless Steel for coastal areas or when stainless steel appearance desired

### IO-210 Series High Intensity Heaters

- Best suited to 'open' patios
- 25,000 and 35,000 Btuh Natural Gas or Propane Gas
- 24V electrical supply & ignition - central or remote control
- All models have a black emissive coated [316] marine grade S/S lens - improves performance and helps heater "disappear"

### Patio Tube Heaters - IW, IW2 & IWP, IWP2

- 40,000 to 150,000 Btuh, 10 ft to 40 ft tube length
- 120V required for burner, but has 24V ignition for central or remote control
- Best suited for covered or enclosed areas - combustion products can be direct vented to beyond the area being heated
- IWP** - Powder coated burner housing for standard covered or enclosed patio application
- IW** - Stainless steel burner housing for harsh or salt-air environments

### ES / ESD Electric heaters

- Instant comfort at the flip of a switch
- Enclosed or covered patios
- 'Tight' spots
- Where long gas pipe runs are impractical



Marine Grade 316 Stainless Steel Finish



Black High Temperature Finish on Marine Grade 316 Stainless Steel Outer Cabinet

### Outdoor IO-100 Series

<u>MODEL</u>	<u>INPUT</u>	<u>FINISH</u>	<u>GAS</u>	<u>PART #</u>	<u>LIST PRICE</u>
IO-135	35,000	Black High Temperature Coat on 316 Stainless	NG	IO-0135-NG	\$ 2,772.00
			LP	IO-0135-LP	2,772.00
IO-150	50,000	Black High Temperature Coat on 316 Stainless	NG	IO-0150-NG	2,997.00
			LP	IO-0150-LP	2,997.00
IO-135-SS	35,000	Marine Grade Stainless Steel [316]	NG	IO-0135-SN	2,772.00
			LP	IO-0135-SL	2,772.00
IO-150-SS	50,000	Marine Grade Stainless Steel [316]	NG	IO-0150-SN	2,997.00
			LP	IO-0150-SL	2,997.00

### 2-Stage ~ 50,000 Btuh High Stage; 36,500 Btuh Low Stage - Natural Gas Only

IO-152	50/36,499	2-Stage - Black High Temp. Coated 316 S/S	NG	IO-0152-NG	\$ 3,297.00
IO-152-SS	50/36,500	2-Stage - Marine Grade Stainless Steel	NG	IO-0152-SN	3,297.00

### IO-100 Faceplate (NEW!)

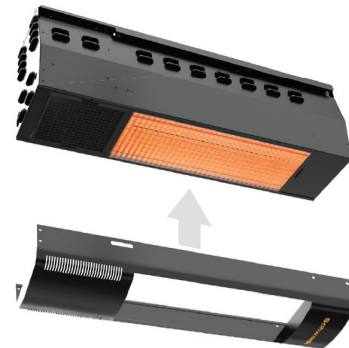

IO-100 Faceplate Assembly Kit (316 S/S)  
 IO-100 Faceplate Assembly Kit (316 S/S) Painted-Black Finish

<u>PART #</u>	<u>LIST PRICE</u>
JJ-2100-FP-S	262.00
JJ-2100-FP-SP	262.00



## Outdoor IO-210 SERIES

**Marine Grade Stainless Steel Housing with Black Emissive Coating**  
 - Helps preserve appearance  
 - Increases IR output

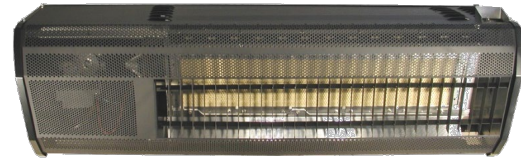

<u>MODEL</u>	<u>INPUT</u>	<u>FINISH - Including Lens Cover</u>	<u>Minimum Mounting Height</u>	<u>PART #</u>	<u>LIST PRICE</u>
<b>IO 212</b>	23,000	Marine Grade S/S BLACK - High Temperature	8 ft	IO-0212-NG IO-0212-LP	\$ 3,038.00 3,038.00
<b>IO 213</b>	35,000	Marine Grade S/S BLACK - High Temperature	8 ft 6 in	IO-0213-NG IO-0213-LP	3,544.00 3,544.00
<b>2-Stage ~ 50,000 Btuh High Stage; 35,000 Btuh Low Stage - Natural Gas Only</b>					
<b>IO 252</b>	50/35000	Marine Grade S/S BLACK - High Temperature	9 ft	IO-0252-NG	\$ 3,679.00

See 2-Stage Illuminated Switch control options previous page

### IO-100 & IO-210 Series Gas Connection

Black Finish Stainless Steel Flexible Gas Connector 3/8" x 24"	JL-0771-OD	\$ 77.00
Flexible Gas Connector 1/2" x 24"	JL-0771-XX	59.00

### Controls & Accessories for IO-100 & IO-210 Systems:

Mounting Options: Next page  
 Controls and 24 VAC guidelines pages 54 - 55

Gas Conversion Kits for IO-100 & IO-210 Series: See Page 10

## MOUNTING OPTIONS

### IO-100 & IO-210 SERIES HEATERS

		<u>PART #</u>	<u>LIST PRICE</u>
<b>Wall Mount Brackets:</b> Mount heater at 30° angle, and combustible clearance from wall			
<b>Wall Mount Bracket: IO-100 Series Models &amp; Model IO-252:</b>			
Mounts heater at 11.5" from wall @ 30°			
~ Provides combustible clearance from wall surface		Painted Steel JP-2100-MB	\$ 268.00
~ 11" x 7" minimum mounting surface footprint		Stainless Steel JP-2100-MB-SS	327.00
<b>Wall Mount Bracket: Models IO-212, IO-213 Only:</b>			
Mounts heater at combustible clearance from wall @ 30°			
		Painted Steel JP-2300-MB	\$ 268.00
		Stainless Steel JP-2300-MB-SS	284.00
<b>4" Pole Mount Assembly:</b>			
<b>IO-100 &amp; IO-210 Series</b>			
Pole Clamp + Heater Bracket			
		Painted Steel JP-2300-PK	\$ 254.00
		Stainless Steel JP-2300-PK-SS	269.00
<b>Wall Mount Arm Kit</b>			
<b>IO-100 &amp; IO-210 Series</b>			
Locates heater 30 inches from mounting surface at 30° Angle			
Hardware needed for fastening to structure is field supplied			
		Painted Steel JP-2300-MK	\$ 395.00
		Stainless Steel JP-2300-MK-SS	545.00
<b>Ceiling Mount Kit</b>			
<b>IO-100 &amp; IO-210 Series</b>			
		Ceiling Mount Kit is Stainless Steel construction ONLY	\$ 210.00
		JP-2100-CB-K	
	One end shown only - two brackets are supplied		

Remote & patioPanel Controls ~ See Next Page for information, sizes & pricing ~

## Remote Control of Patio Systems

### Remote Receiver, Hand Set & Wireless Keypad Options

ORDER ITEMS SEPARATELY

- 1) Remote Control Receiver Kit field installs in burner: REQUIRED
  - Order one for each heater - High Intensity or Tube type
  - Includes receiver, wires, instructions



JP-1236-RK \$ 272.00



- 2) Hand Set Control [four On/Off buttons]: REQUIRED
  - Order one for every four zones: a Zone is 1 or more heaters
  - Control up to 4 individual heaters or up to 4 zones with multiple heaters in each zone
  - At least one hand set is always required for master programming of receiver or Keypad
  - Infrasave recommends ordering two hand sets for each control area [4 heaters or zones] so that a back-up hand-set is always available if one is misplaced....
  - OR - order one master hand set and Keypad Transmitter [below] for each 4 zones

JP-1236-HS 144.00



- 3) Wireless Remote Control Keypad Transmitter: OPTIONAL
  - [Note: Above Hand Set Control is required for Master Code programming]
  - Control up to four patio zones:
    - 3 Zones with unique 4 digit PIN
    - Plus 1 zone with direct push button
  - Weather resistant: Outdoor or indoor installation
  - No more misplaced hand sets

JP-1236-KT 190.00

## Central Panel Control of Patio Systems

Single HEATER per each panel switch recommended for best comfort control

- Panel switches have 24 volt capacity

24 Volt SYSTEM TRANSFORMER NOT INCLUDED - SEE NEXT PAGE for SIZES & PRICING.

MODEL	HEATERS	PART #		LIST PRICE
PCP-4	Up To 4	JM-0204-NT	\$	458.00
PCP-8	Up To 8	JM-0208-NT	\$	572.00
PCP-12	Up To 12	JM-0212-NT	\$	664.00



## 24 Volt Control Guidelines

### IO-100 & IO-210 Series

### ~ High Intensity Heaters

- Size 24V transformer 40VA for 1st heater + 20 VA for each additional heater
- Patio Panel switches are 24 volt capacity
- Patio Panel: Size transformer for ALL heaters controlled by each individual panel
- for best comfort control, assign one heater to each Patio Panel switch
- At most two IO-210 heaters can be assigned to each Patio Panel switch
- Remote Control: Size transformer[s] for ALL heaters installed on the patio

### IWP(2) & IW(2) Series

### ~ Tube Heaters

- 120 V supply is ALWAYS required to the burner to power the blower and the individual transformer in each burner assembly
- Patio Panel: 24V power to the panel switch is supplied from the transformer within the heater's burner
- ONLY ONE tube heater can be controlled by each Patio Panel switch
- Remote Control: The Burner is ready for installation of Remote Control Receiver Kit: JP-1236-RK

## 2-Stage Controls: Illuminated Switch Gang

**Required for Control of 2-Stage Heater Systems Only: Models IO-152 & IO-252**

### Model IO-152; Model IO-252

- Brushed Stainless Cover Plate; Factory Wired; Electrical Box Supplied; 24 Vac Capacity [Transformer field supplied]



JM-0201-TS



JM-0202-TS

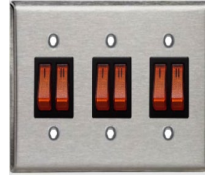

JM-0203-TS

Switch gangs have special "Off, On, On" sequence required for heater operation

Do Not Use a switch with "On, Off, On" sequence

<u>24VAC SWITCH</u>	<u>CONTROL</u>	<u>PART #</u>		<u>LIST PRICE</u>
Single Switch Gang	1 Zone of 1 To 4 Heaters	JM-0201-TS	\$	107.00
Double Switch Gang	2 Zones: 2 To 8 Heaters	JM-0202-TS		189.00
Triple Switch Gang	3 Zones: 3 To 12 Heaters	JM-0203-TS		272.00

## ZONE TRANSFORMERS 24Vac

**For All IO-100 & IO-210 Series Models**

A Patio Panel requires a 24 volt Transformer to power the panel switches, and in turn power the heater[s]. The transformer is sized to suit the total number of heaters being controlled by the panel - see below for sizing guide.

IO-100 & IO-210 Series heaters require a 24 volt transformer[s] sized to suit the total number of heaters installed - see below for sizing guide.

**Refer to previous page for guidelines on 24 Volt control of IO-100 & IO-210 heating systems**

### 24V TRANSFORMER SIZING GUIDE: IO-100 & IO-210 Series heaters

- On a single heater use one 40 VA transformer.
- On a zone with multiple heaters, use a transformer sized at 40 VA per first heater and 20 VA per each additional heater.

### 24V TRANSFORMERS

<u>SIZE</u>	<u>HEATER QTY</u>		<u>PART #</u>		<u>LIST PRICE</u>
40 VA Transformer	1	4"x 4" Electrical Box Mount	JL-0776-XX	\$	126.00
100 VA Transformer	Up to 4	Closed Type	JL-0778-XX		234.00
150 VA Transformer	Up to 6	Closed Type	JL-0779-XX		281.00
200 VA Transformer	Up to 9	Closed Type	JL-0780-XX		321.00
250 VA Transformer	Up to 11	Closed Type	JL-0781-XX		350.00
350 VA Transformer	Up to 16	Closed Type	JL-0781-AA		409.00

See **INSTALLATION MANUAL** to determine gauge of distribution wire. [minimum 16 gauge].

Specific information on each of the Outdoor Tube Heater Series is in this Price List on pages as noted below.

## Models: P40U-IP, -IW

See Page 15 for information on the P40U-IP / -IW



Factory assembled heater  
 Installs directly from carton  
 Compact 10 ft 3 inch total length design

Model P40U-P/-W: Weather tight burner housing

Please note that larger input models 175,000 and 200,000 Btuh for the following Tube Series are not suitable for Patio application

## Models IWP & IWP2

See Pages 36 to 39 for information on the IWP & IWP2

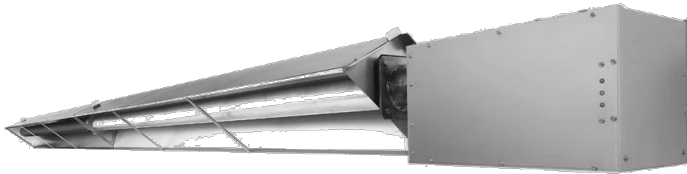

**Powder Coated Cabinet.**  
*Economical heating for covered or enclosed patios*

*Model IWP shown with optional Tuxedo Grille*

## Model IW, IW2 & IWS, IW2S

See Pages 40 to 43 for information on the IW & IW2

See Pages 44 to 47 for information on the IWS & IW2S ALL Stainless Steel Series



**STAINLESS STEEL BURNER CABINET**  
**BEST for Salt-Air Coastal Regions**

*Model IW shown with optional Tuxedo Grille*

**Accessories for Outdoor Tube Heaters are listed on Pages 48 & 49**

**PARASOL STAINLESS STEEL  
4000 SERIES  
PORTABLE MOUNT  
FOR OUTDOOR PATIOS**

**4005-CB Portable**

**Premier Commercial  
Stainless Steel Finish**

- 38,000 Btuh Conical Burner
- 16% LESS FUEL USE than 45,000 Btuh heaters.
  - Fuel tank lasts longer*
  - Labor saved with fewer tank changes*
- Conical burner has inner & outer radiant heat emitters:
  - Increases radiant heat output
  - Conical shape directs heat to patio patrons
- Single piece 32" reflector
- Battery electronic ignitor
- Portable model has large 4" diameter wheels for easy portability
  - Housing for 20 lb tank [L.P. tank not included]
- Three year commercial use warranty on burner



**4005-CB\***  
Stainless Steel  
Portable

Portable 4005-CB\* Stainless Steel Finish

<u>MODEL</u>	<u>FINISH</u>	<u>Gas Type</u>	<u>INPUT</u>	<u>ORDER PART #</u>	<u>LIST PRICE</u>
4005-CB*	Stainless Steel [304]	LP Gas Only	38,000 Btuh	PS-4005-CB	\$ 1,183.00
* Ships in two separate cartons: 1: Burner, post, tank cover, base + 2: Reflector JP-4070-CB					
32" Single Piece Replacement Reflector				JP-4070-CB	\$ 197.00
Base weight for 4005 portable heater				JP-4089-XX	49.00



**Applications:**

- Patios
- Sports venues
- Outdoor smoking areas
- Balcony/terrace
- Hobby shops
- Garage/workshop
- Warehouse facilities

**ES/ESD electricSeries IR Heater**  
**Mid-Wave Infrared for Instant Comfort**  
**Single & Dual Bulb Models**

Standard heaters are Stainless Steel Finish - Color Finish Options Available (see below)

**Heaters greater than 1500 Watts are for "Commercial Use Only."**  
**Do not use as a residential or household heater. Risk of fire.**

Available in 500, 750, 1000, 1500, 2000, 2500, 3000, 4000, 5000, and 6000 Watts

<u>Model</u>	<u>Application</u>	<u>Capacity</u>	<u>Electrical</u>		<u>Part #</u>	<u>List Price</u>
			<u>Voltage</u>	<u>Amps</u>		
ES-519	Outdoor / Indoor **	500 Watts	120Vac	4.2	ES-0519-12	\$ 699.00
ES-719	Outdoor / Indoor **	750 Watts	120Vac	6.3	ES-0719-12	699.00
ES-1033	Outdoor / Indoor **	1000 Watts	120Vac	8.3	ES-1033-12	715.00
ES-1533	Outdoor / Indoor **	1500 Watts	120Vac	12.5	ES-1533-12	744.00
ES-1533	Outdoor / Indoor **	1500 Watts	208Vac	7	ES-1533-20	744.00
ES-1533	Outdoor / Indoor **	1500 Watts	240Vac	6.3	ES-1533-24	744.00
ES-2039	Outdoor / Indoor	2000 Watts	208Vac	10	ES-2039-20	772.00
ES-2039	Outdoor / Indoor	2000 Watts	240Vac	8.3	ES-2039-24	772.00
ES-2539	Outdoor / Indoor	2500 Watts	208Vac	12	ES-2539-20	794.00
ES-2539	Outdoor / Indoor	2500 Watts	240Vac	10.4	ES-2539-24	794.00
ESD-3033	Outdoor / Indoor	3000 Watts	208Vac	14	ES-3033-20	945.00
ESD-3033	Outdoor / Indoor	3000 Watts	240Vac	12.5	ES-3033-24	945.00
ES-3061	Outdoor / Indoor	3000 Watts	208Vac	14	ES-3061-20	1,035.00
ES-3061	Outdoor / Indoor	3000 Watts	240Vac	12.5	ES-3061-24	1,035.00
ESD-4039	Outdoor / Indoor	4000 Watts	208Vac	19	ES-4039-20	945.00
ESD-4039	Outdoor / Indoor	4000 Watts	240Vac	16.7	ES-4039-24	945.00
ES-4061	Outdoor / Indoor	4000 Watts	208Vac	19	ES-4061-20	1,035.00
ES-4061	Outdoor / Indoor	4000 Watts	240Vac	16.7	ES-4061-24	1,035.00
ESD-5039	Outdoor / Indoor	5000 Watts	208Vac	24	ES-5039-20	1,078.00
ESD-5039	Outdoor / Indoor	5000 Watts	240Vac	20.8	ES-5039-24	1,078.00
ESD-6061	Outdoor / Indoor	6000 Watts	208Vac	28.8	ES-6061-20	1,239.00
ESD-6061	Outdoor / Indoor	6000 Watts	240Vac	25	ES-6061-24	1,239.00

**Note: 2000W to 6000W heaters are also available in \*277V and \*480V. Please contact your sales rep for information**

\*\* Typically recommended for indoor use due to the low wattage. Suitable for Residential application.

**Custom Color Options:**

A Heater is available in the following custom colors. Black, White, Beige, Mineral Bronze, Almond, Biscuit.

**Please contact your sales rep for information on how to order colored heaters & frame kits.**

JE-0500-	130.00
JE-0520-	130.00

**Recessed Mounting Options:**

33" recessed mount frame S/S	JE-0520-33	787.00
39" recessed mount frame S/S	JE-0520-39	787.00
61.25" recessed mount frame S/S	JE-0520-61	713.00





ON/OFF



2 STAGE



VARIABLE

**Control Options:**

Application

	<u>Electrical</u>		<u>Part #</u>	<u>List Price</u>
	<u>Voltage</u>	<u>Amps</u>		
<b>ON / OFF CONTROLS</b>				
<b>Designed for use with single bulb 120volt heaters ONLY.</b>				
Single - Flush Mount c/w S/S Wall Plate and Deep Gang Box	120v	15 Max	JM-4100-XX	\$ 166.00
Dual - Flush Mount c/w S/S Wall Plate and Deep Gang Box	120v	15 Max	JM-4105-XX	280.00
Single - Flush Mount c/w Weatherproof Cover	120v	15 Max	JM-4110-XX	181.00
Dual - Flush Mount c/w Weatherproof Cover	120v	15 Max	JM-4115-XX	324.00
Single - Surface Mount c/w Weatherproof Gang Box and Cover	120v	15 Max	JM-4120-XX	211.00
Dual - Surface Mount c/w Weatherproof Gang Box and Cover	120v	15 Max	JM-4125-XX	340.00
<b>ON / OFF CONTROLS</b>				
<b>Designed for use with single bulb heaters 208-277volt ONLY.</b>				
Single - Flush Mount c/w S/S Wall Plate and Deep Gang Box	208/240/277V	20 Max	JM-4400-XX	\$ 166.00
Dual - Flush Mount c/w S/S Wall Plate and Deep Gang Box	208/240/277V	20 Max	JM-4405-XX	280.00
Single - Flush Mount c/w Weatherproof Cover	208/240/277V	20 Max	JM-4410-XX	181.00
Dual - Flush Mount c/w Weatherproof Cover	208/240/277V	20 Max	JM-4415-XX	324.00
Single - Surface Mount c/w Weatherproof Gang Box and Cover	208/240/277V	20 Max	JM-4420-XX	211.00
Dual - Surface Mount c/w Weatherproof Gang Box and Cover	208/240/277V	20 Max	JM-4425-XX	340.00
<b>2 STAGE CONTROLS</b>				
<b>Designed for use with dual bulb ESD heaters ONLY. (Ability to turn each bulb on and off independently).</b>				
Single Duplex - Flush Mount c/w S/S Wall Plate and Gang Box	208/240/277V	20 Per switch	JM-4300-XX	\$ 181.00
Dual Duplex - Flush Mount c/w S/S Wall Plate and Deep Box	208/240/277V	20 Per switch	JM-4305-XX	296.00
Single Duplex - Flush Mount c/w Weatherproof Cover	208/240/277V	20 Per switch	JM-4310-XX	211.00
Dual Duplex - Flush Mount c/w Weatherproof Cover	208/240/277V	20 Per switch	JM-4315-XX	340.00
Single Duplex - Surface Mount c/w Weatherproof Box and Cover	208/240/277V	20 Per switch	JM-4320-XX	230.00
Dual Duplex - Surface Mount c/w Weatherproof Box and Cover	208/240/277V	20 Per switch	JM-4325-XX	367.00
<b>VARIABLE CONTROLS</b>				
<b>Designed for use with single bulb heaters up to 3000 watts ONLY (max 15 amps).</b>				
Single - Flush Mount c/w S/S Wall Plate and Deep Gang Box	240V	15 Max	JM-4200-XX	\$ 181.00
Dual - Flush Mount c/w S/S Wall Plate and Deep Gang Box	240V	15 Max	JM-4205-XX	296.00
Single - Flush Mount c/w Weatherproof Cover	240V	15 Max	JM-4210-XX	211.00
Dual - Flush Mount c/w Weatherproof Cover	240V	15 Max	JM-4215-XX	340.00
Single - Surface Mount c/w Weatherproof Gang Box and Cover	240V	15 Max	JM-4220-XX	230.00
Dual - Surface Mount c/w Weatherproof Gang Box and Cover	240V	15 Max	JM-4225-XX	367.00

## Electric Heater - Electromechanical Relay Package

Schwank offers a wide range of custom control options in our industry to meet the needs of any residential or commercial application. The Electromechanical Relay (EMR) package allows you to install and control your heaters using any 24/120V thermostat or our TC Plus controller. It also provide you the capability to control one or more heaters in a specified zone (Zone Heating).

This package includes NEMA 4 rated enclosure kit and appropriate relay depending on the number of heater amp draw

**NOTE: All electrical parts will be shipped loose and the wiring should be completed in the field by an authorized electrician/contractor. It should be approved by the local jurisdiction**

		<b>Part #</b>	<b>List Price</b>
<b>Control Panel Enclosure Kit - NEMA 4 RATED</b>			
Kit Includes 1 x Enclosure - NEMA 4 RATED 1 x Transformer - 40VA 1 x Terminal Block		JM-4000-XX	757.00
		JM-4005-XX	
		JA-0777-XX	
		JM-0455-DD	
<b>Electromechanical Relays (EMR)</b>			
18 Amp Relay - 18A/600VAC/24VAC		JM-4010-XX	167.00
32 Amp Relay - 32A/600VAC/24VAC		JM-4015-XX	266.00
50 Amp Relay - 50A/600VAC/24VAC		JM-4020-XX	479.00
75 Amp Relay - 75A/600VAC/24VAC		JM-4025-XX	606.00

**NOTES:**

- Each relay can handle up to 3 heaters
- Each control panel (enclosure) fits maximum of 2 relays
- Please refer to the table below to select the appropriate relay size

Heater Capacity (W)	Voltage				
	120	208	240	277	480
500	18A	-	-	-	-
750	18A	-	-	-	-
1000	18A	-	-	-	-
1500	32A	18A	18A	-	-
2000	-	32A	18A	18A	18A
2500	-	32A	32A	32A	18A
3000	-	32A	32A	32A	18A
4000	-	50A	50A	32A	32A
5000	-	75A	75A	50A	32A
6000	-	75A	75A	75A	32A



Zone Analog Controller  
(with and without timer)



Solid State Relay Panel



Home Management Relay Panel

## Electric Heater - Solid State Control Options :

### ZONE ANALOG CONTROLLER

The ability to adjust heating intensity. All Controllers are NEMA 12 RATED, and can be exposed to mist, but not direct rain. Each Intensity Control Knob can control a maximum of three relays in the Relay Panel.

- 1 Zone Analog Controller with Digital Timer
- 2 Zone Analog Controller with Digital Timer
- 3 Zone Analog Controller with Digital Timer
- 4 Zone Analog Controller with Digital Timer

<u>Part #</u>	<u>List Price</u>
JM-4045-XX	1,212.00
JM-4046-XX	1,530.00
JM-4047-XX	1,867.00
JM-4048-XX	2,213.00

### SOLID STATE RELAY PANEL

The Solid State Relay Panel and Zone Analog Controller (with or without optional timer) work together. All Relay Panels are NEMA 4 RATED, and completely weather resistant. Maximum of 9,000 watts @ 240V or 8,000 watts @ 208V per relay.

- 1 Relay Control Panel
- 2 Relay Control Panel
- 3 Relay Control Panel
- 4 Relay Control Panel
- 5 Relay Control Panel
- 6 Relay Control Panel

<u>Part #</u>	<u>List Price</u>
JM-4051-XX	\$ 1,809.00
JM-4052-XX	2,364.00
JM-4053-XX	2,999.00
JM-4054-XX	3,632.00
JM-4055-XX	4,392.00
JM-4056-XX	5,143.00

### HOME MANAGEMENT RELAY PANEL

Integrate electricSchwank heaters directly into your home management system. All Relay Panels are NEMA 4 RATED, and completely weather resistant. Note: Requires 0-10V DC Signal

- 1 Relay Home Management Control Panel
- 2 Relay Home Management Control Panel
- 3 Relay Home Management Control Panel
- 4 Relay Home Management Control Panel
- 5 Relay Home Management Control Panel
- 6 Relay Home Management Control Panel

<u>Part #</u>	<u>List Price</u>
JM-4061-XX	\$ 3,214.00
JM-4062-XX	4,439.00
JM-4063-XX	6,600.00
JM-4064-XX	7,650.00
JM-4065-XX	9,969.00
JM-4066-XX	10,992.00

**Note: Please contact your sales rep for information on our custom designed Solid State Relay Control Packages**

## GAS CONVERSION KITS

Only Conversion Kits for Current Production Orders are Listed Below.

Burners in your stock, and installed in the field: 2

To ensure correct kit:

- **Model # & Serial # MUST be provided** (located on Burner rating plate).
- Contact Customer Service 1-877-686-3779

## Infrasave TUBE HEATERS

NOTE: Conversion kits are NOT available for Tube Heater Models: IT, IRB

As safe practice, Infrasave does not recommend or support fuel conversion of heaters that have been in service for 10 years or longer.

Heater Model	Input	NG to LP	LP to NG	List Price	List Price
<b>P40-R, P40U-I, P40U-IP, P40U-IW</b>	40,000	JS-0555-XA	JS-0555-XB	\$ 47.00	\$ 47.00
<b>MODELS: IQ, ITB, IWP, IW</b>	45,000	JS-0556-XC	JS-0556-XD	86.00	86.00
	60,000	JS-0557-XX	JS-0558-XX	45.00	45.00
	80,000	JS-0559-XX	JS-0560-XX	45.00	45.00
	100,000	NG ONLY - Not Convertible			
	110,000 1	JS-0561-XB	JS-0562-XB	198.00	153.00
	125,000 3	JS-0563-XB	JS-0564-XB	76.00	76.00
	150 / 155,000	JS-0565-XX	JS-0566-XX	45.00	45.00
	175,000 1, 3	JS-0567-AS	JS-0567-BS	153.00	150.00
	200,000 1, 3	JS-0567-CS	JS-0567-DS	96.00	77.00

\*\* NOTES: 1. 110,000, 175,000 & 200,000 Burners for LP:

These input rate burners require more extensive conversion in the field

Conversion is available, but best to order burners produced in LP from the factory

2. Different burner configurations exist for some burner input rates.

MUST provide Model and Serial Numbers to Customer Service 1-877-686-3779

3. Check specific model price pages or manual for length restrictions with LP burners

MODEL: ITT	Input	NG to LP	LP to NG	List Price	List Price
	80/60,000	JS-0555-TC	JS-0555-TD	\$ 75.00	\$ 75.00
<b>2-STAGE TUBE HEATERS</b>	110,75,000	JS-0555-TG	JS-0555-TH	75.00	75.00
	125/90,000	JS-0555-TK	JS-0555-TL	75.00	75.00
	155/110,000	JS-0555-TO	JS-0555-TP	75.00	75.00

	Input	NG to LP	Burner Type	List Price
<b>superTube IST Models Single-Stage</b>	50,000	JS-0553-AL	1-stage	59.00
	65,000	JS-0553-BL	1-stage	59.00
	80,000	JS-0553-CL	1-stage	59.00
	115,000	JS-0553-DL	1-stage	59.00
	130,000	JS-0553-EL	1-stage	59.00
	155,000	JS-0553-FL	1-stage	59.00
	180,000	JS-0553-GL	1-stage	59.00
	205,000	JS-0553-HL	1-stage	59.00
	225,000	JS-0553-JL	1-stage	59.00
	250,000	JS-0553-KL	1-stage	59.00
<b>superTube IST Models Two-Stage</b>	50,000	JS-0554-LL	2-stage	71.00
	65,000	JS-0554-ML	2-stage	71.00
	80,000	JS-0554-NL	2-stage	71.00
	115,000	JS-0554-PL	2-stage	71.00
	130,000	JS-0554-RL	2-stage	71.00
	155,000	JS-0554-SL	2-stage	71.00
	180,000	JS-0554-TL	2-stage	71.00
	205,000	JS-0554-UL	2-stage	71.00
	225,000	JS-0554-VL	2-stage	71.00
	250,000	JS-0554-WL	2-stage	71.00



## MonsterFans Style Series

FAN DIAMETERS		
Model #	Description	List Price
MF-ST07-GY	MonsterFans Style Series 7 FT with Controls, Grey Color	\$ 6,649.00
MF-ST08-GY	MonsterFans Style Series 8 FT with Controls, Grey Color	\$ 6,649.00
MF-ST09-GY	MonsterFans Style Series 9 FT with Controls, Grey Color	\$ 6,649.00
MF-ST10-GY	MonsterFans Style Series 10 FT with Controls, Grey Color	\$ 6,649.00
MF-ST07-BK	MonsterFans Style Series 7 FT with Controls, Black Color	\$ 6,649.00
MF-ST08-BK	MonsterFans Style Series 8 FT with Controls, Black Color	\$ 6,649.00
MF-ST09-BK	MonsterFans Style Series 9 FT with Controls, Black Color	\$ 6,649.00
MF-ST10-BK	MonsterFans Style Series 10 FT with Controls, Black Color	\$ 6,649.00
MF-ST07-WH	MonsterFans Style Series 7 FT with Controls, White Color	\$ 6,649.00
MF-ST08-WH	MonsterFans Style Series 8 FT with Controls, White Color	\$ 6,649.00
MF-ST09-WH	MonsterFans Style Series 9 FT with Controls, White Color	\$ 6,649.00
MF-ST10-WH	MonsterFans Style Series 10 FT with Controls, White Color	\$ 6,649.00
MF-ST07-SL	MonsterFans Style Series 7 FT with Controls, Silver Color	\$ 6,649.00
MF-ST08-SL	MonsterFans Style Series 8 FT with Controls, Silver Color	\$ 6,649.00
MF-ST09-SL	MonsterFans Style Series 9 FT with Controls, Silver Color	\$ 6,649.00
MF-ST10-SL	MonsterFans Style Series 10 FT with Controls, Silver Color	\$ 6,649.00
MF-ST07-RD	MonsterFans Style Series 7 FT with Controls, Red Color	\$ 6,649.00
MF-ST08-RD	MonsterFans Style Series 8 FT with Controls, Red Color	\$ 6,649.00
MF-ST09-RD	MonsterFans Style Series 9 FT with Controls, Red Color	\$ 6,649.00
MF-ST10-RD	MonsterFans Style Series 10 FT with Controls, Red Color	\$ 6,649.00
MF-ST07-BU	MonsterFans Style Series 7 FT with Controls, Blue Color	\$ 6,649.00
MF-ST08-BU	MonsterFans Style Series 8 FT with Controls, Blue Color	\$ 6,649.00
MF-ST09-BU	MonsterFans Style Series 9 FT with Controls, Blue Color	\$ 6,649.00
MF-ST10-BU	MonsterFans Style Series 10 FT with Controls, Blue Color	\$ 6,649.00
Controls		
Model #	Description	List Price
JV-01048-CL	MonsterFans Style Series Multi-Fan HMI Control	\$ 1,016.00
JV-01020-CL	MonsterFans Smart Controller, Single Fan, Touchscreen, Temp/RH sensor	\$ 1,148.00
JV-01025-CL	MonsterFans Smart Controller, Multiple Fans, Up to 10 Fans, Touchscreen, Temp/RH sensor	\$ 2,592.00
JV-01030-CL	MonsterFans Touch Controller, Up to 20 Fans, Touchscreen, On/Off, Speed Control, Reverse	\$ 5,333.00
JV-01035-CL	MonsterFans Touch Module	\$ 616.00
JV-01040-CL	MonsterFans Link Controller - BMS	\$ 3,078.00
JV-01045-CL	MonsterFans Link Module - BMS	\$ 329.00
Mounting Kits		
Model #	Description	List Price
JV-0003-MK-E	MonsterFans Style Series Extension Mounting Kit, 3 FT	\$ 233.00
Accessories		
Model #	Description	List Price
JV-01072-CL	Style Series Fire Relay	\$ 113.00
JV-01075-CL	MonsterFans Wind Sensor	\$ 1,166.00



## MonsterFans Geared-Drive [GD] Series

### FAN DIAMETERS

Model #	Description	List Price
MF-GD08-XX	MonsterFans GD Series 8 FT, Geared Motor, 230/460V	\$ 7,119.00
MF-GD12-XX	MonsterFans GD Series 12 FT, Geared Motor, 230/460V	\$ 7,119.00
MF-GD16-XX	MonsterFans GD Series 16 FT, Geared Motor, 230/460V	\$ 7,609.00
MF-GD20-XX	MonsterFans GD Series 20 FT, Geared Motor, 230/460V	\$ 8,113.00
MF-GD24-XX	MonsterFans GD Series 24 FT, Geared Motor, 230/460V	\$ 8,940.00
MF-GD08-YY	MonsterFans GD Series 8 FT, Geared Motor, 575V	\$ 7,946.00
MF-GD12-YY	MonsterFans GD Series 12 FT, Geared Motor, 575V	\$ 7,946.00
MF-GD16-YY	MonsterFans GD Series 16 FT, Geared Motor, 575V	\$ 8,443.00
MF-GD20-YY	MonsterFans GD Series 20 FT, Geared Motor, 575V	\$ 8,940.00
MF-GD24-YY	MonsterFans GD Series 24 FT, Geared Motor, 575V	\$ 9,767.00

### VFD

Model #	Description	List Price
JV-01010-CL	MonsterFans Drive, VFD 230V IP66 NEMA 4X Rating	\$ 1,404.00
JV-01015-CL	MonsterFans Drive, VFD 460V IP66 NEMA 4X Rating	\$ 1,695.00
JV-01050-CL	MonsterFans Drive, VFD 575V 1HP, GD Series	\$ 1,896.00
JV-01053-CL	MonsterFans Drive, VFD 575V 1.5HP, GD Series	\$ 2,071.00
JV-01056-CL	MonsterFans Drive, VFD 575V 2HP, GD Series	\$ 2,071.00

### Controls

Model #	Description	List Price
JV-01005-CL	MonsterFans Simple Controller, Single Fan, On/Off, Speed Control, Reverse	\$ 727.00
JV-01020-CL	MonsterFans Smart Controller, Single Fan, Touchscreen, Temp/RH sensor	\$ 1,148.00
JV-01025-CL	MonsterFans Smart Controller, Multiple Fans, Up to 10 Fans, Touchscreen, Temp/RH sensor	\$ 2,592.00
JV-01030-CL	MonsterFans Touch Controller, Up to 20 Fans, Touchscreen, On/Off, Speed Control, Reverse	\$ 5,333.00
JV-01035-CL	MonsterFans Touch Module	\$ 616.00
JV-01040-CL	MonsterFans Link Controller - BMS	\$ 3,078.00
JV-01045-CL	MonsterFans Link Module - BMS	\$ 329.00

### Mounting Kits

Model #	Description	List Price
JV-0001-MK	MonsterFans DD/GD Series Primary Mounting Kit, 1 FT	\$ 291.00
JV-0002-MK	MonsterFans DD/GD Series Primary Mounting Kit, 2 FT	\$ 340.00
JV-0004-MK	MonsterFans DD/GD Series Primary Mounting Kit, 4 FT	\$ 387.00
JV-0002-MK-E	MonsterFans DD/GD Series Extension Mounting Kit, 2 FT	\$ 242.00
JV-0004-MK-E	MonsterFans DD/GD Series Extension Mounting Kit, 4 FT	\$ 291.00
JV-0010-MK	MonsterFans Mounting Kit, OWSJ Bracket (one per truss)	\$ 174.00
JV-0012-MK	MonsterFans Mounting Kit, Glue Lam Bracket (one per fan)	\$ 240.00
JV-0014-MK	MonsterFans Mounting Kit, Purlon Bracket (one per truss)	\$ 214.00
JV-0018-MK	MonsterFans Matching Mount Plate Kit, (one per fan)	\$ 92.00
JV-0020-MK	MonsterFans Mounting Kit, 8' Steel Mounting Beam	\$ 399.00
JV-0023-MK	MonsterFans Mounting Kit, 13' Steel Mounting Beam	\$ 835.00

### Accessories

Model #	Description	List Price
JV-01070-CL	External VFD Fire Relay - 30A - 24V	\$ 117.00
JV-01075-CL	MonsterFans Wind Sensor	\$ 1,166.00

## WARRANTY SUMMARY

Infrasave Product	WARRANTY TERM (YEARS)					
	All Heaters	Luminous	Tube Heaters		Outdoor Parasol	
	Components	Ceramic Tile	Burner C u p	Radiating T u b e s	Burner	Mantle
<b>LUMINOUS HEATERS:</b> IL Series	2	10				
<b>TUBE HEATERS:</b> Premier – IQ Series Builder – ITB(U) Series Two-stage – ITT(U) Series P40U- Series (-IP, -IW) Residential - P40-R Vented Room Heater	3 2 2 3 3		10 5 5 10 10	10 5 5 10 10		
<b>OUTDOOR/WET ENVIRONMENT HEATERS:</b> Luminous IO-100 Series Luminous IO-210 Series Tube Heaters: IWP / IWP2 & IW / IW2 / IWS / IWS2 Parasol 4000 ES /ESD Electric IR	1 1 3 1 2	3 3	10	10	3	3
<b>AIR CURTAINS</b> 500 Series – Drive-Thru Window 1200 Series 2000 & 2500 Series	1 1 2					

**OPTIONAL ACCESSORIES AND REPLACEMENT PARTS ARE COVERED BY THE PART MANUFACTURER'S WARRANTY: TYPICALLY 1 YEAR**

Product warranties consist only of providing a like replacement part for a defective part during the term of the warranty, F.O.B. InfraSave.

Please note, that the above does not constitute a description of product warranty. This table is intended only as a summary of general warranty term information and is subject to change without notice.

Individual product warranty statements are supplied within each product manual.